

# ASTRO-PHYSICS GTO KEYPAD

## Version v4.12

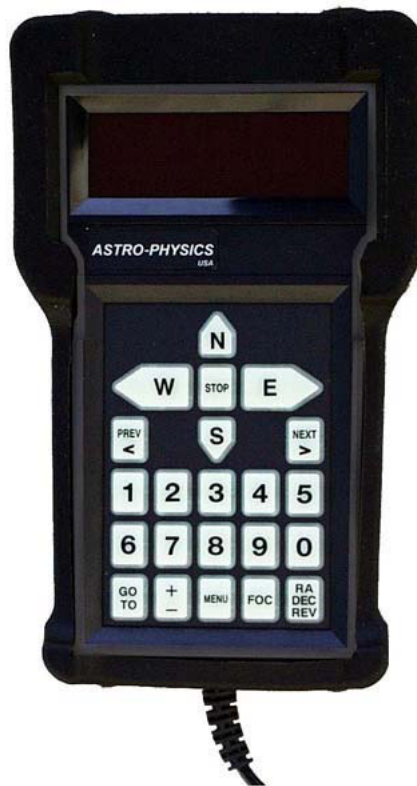

*GTO Keypad with Keypad Protector*

### *Flash RAM Updates*

This and future keypad flash RAM updates can be accomplished through the Internet.

Check our web site [www.astro-physics.com](http://www.astro-physics.com) periodically for further information.

February 8, 2005



# ASTRO-PHYSICS

## GTO KEYPAD CONTROLLER v4.12

GTO Keypad Controller	7
Layout and Buttons of the Keypad	7
Vacuum Fluorescent Display	7
N - S - E - W Directional Buttons	7
RA/DEC REV Button:	7
STOP Button	8
Number Buttons	8
<PREV and NEXT> Buttons	8
GOTO Button	8
+ - Button	8
MENU Button	8
FOC Button	8
Retractable Hanger	8
Keypad Protector	9
Keypad Care and Warranty	9
New Features of Version 4.12	11
09-06-04 Version 4.12	11
08-28-04 Version 4.11	11
08-26-04 Version 4.10	11
02-16-04 Version 4.07	12
Features from version 3.2 (3.2 was only shipped with new mounts or repairs)	13
Getting Started - Do this at home, if possible	14
Setup your Mount and Cable Connections	14
Gather Basic Information	14
Enter Your Location, Date and Time	14
Practice Using your Keypad	15
Your First Observing Session with V4.12	16
Normal Startup Sequence - For Mounts That are Setup in the Field	17
Assemble Your Mount	17
Startup sequence	17
Star Sync	17
Polar Alignment – Which method to choose?	18
N Polar Calibrate - Calibrating with Polaris	18
Two-Star Calibration	19
Resume from Park	21
Resume Ref-Park 1	21
Alternate Polar Calibration Routines & Tips	22
Polar Aligning in the Daytime	22
GTO Quick Star Drift Method of Polar Alignment – Using the Meridian Delay Feature	24
Roland's Favorite Polar Calibration Routine	25
Using Software to Improve Pointing Accuracy	25
How to Find Objects if You Have Less Than Perfect Polar Alignment or Non-Orthogonal Systems	26
What if I Lose My Calibration?	26
Auto-Connect Sequence - For Permanent, Polar-Aligned Mounts	27
Important Points	27

External Startup Sequence – For Mounts that are controlled by an External Computer.	29
Important Point	29
Objects Menu - Have some fun!	30
Tips for Using the Buttons and Menus	30
Procedures Common to all Slewing Commands	30
M, NGC, IC	31
Common Object Names	31
Solar System Objects (Sol)	31
Common Star Names - Non-scientific	32
Greek Star Names, organized by constellation	32
Abell Galaxy Clusters	32
ADS Double Stars (Aitken Double Star Catalog)	33
Search for Objects by Type, Magnitude, Catalog and All Sky vs. Current Constellation	33
What's Up Now Function	34
Tour Objects within Constellations	34
Custom RA and DEC Coordinates	34
Custom ALT / AZ Coordinates	35
Sun Warning	35
Main Menu functions	36
Brightness of the display screen	36
Directional buttons	36
Objects	36
Setup	36
Tools	36
Time/LST	36
Slew rate (S:)	36
Button rate (B:)	36
Guiding rate(A:)	37
Tracking rate (T:)	37
Casual observing	37
Setup Menus	38
Locations & Time Menu	38
Set Site Location	38
Set Date & Time	38
Get Time/Loc FrMnt	38
Mount Move Limits Menu	39
R.A. Backlash Adjustment	39
Declination Backlash Adjustment	39
Set Safe Zone Limits for Your Telescope	41
Set Horizon Limits for Your Telescope	42
Keypad Options Menu	43
Auto-Connect	43
Reticle Illuminator Adjustment	43
Focus Adjustment	43
Keypad Update Menu	44
Park / Mount Options	45
Park Your Telescope	45
Consideration	45
Park – 3 Positions	45
Auto-Park – Park Wherever You Want	46

Parking and Power Considerations	46
Calibrate Menu	46
What if I lose my calibration?	46
Specify Mount Type	46
Tools Menu	47
Permanent Error Memory Adjustment (PEM)	47
Photographic Timer	48
SmartGuide	48
Status	49
Slewing During the Day	51
Potential Dangers	51
How to Observe Safely	51
Orthogonality	52
Check Orthogonality	52
Effect of Non-orthogonality on Polar Alignment	53
Polar Alignment with Non-orthogonal Telescopes	53
Additional Tips for Non-Orthogonal Systems	54
Advanced Features	55
Sync Function	55
Tweak Your Pointing Accuracy	55
Meridian Delay Function	56
SmartGuide	56
Understanding the Keypad Controller and GTO Control Box Functions	57
Functions of the GTO Servo Control Box	57
Functions of the Keypad	57
Upgrading the GTO Servo Control Box	58
Upgrading the Keypad	58
Upgrading or Repairing the Keypad Database	58
Troubleshooting	59
Using <i>TheSky</i> ™ Software V. 5.00.014 or Later	63
Appendix A: RS-232 Command Language - Firmware Versions C, KC, D or KD	66
General Telescope Information:	66
Telescope Motion	67
Position	69
Miscellaneous	70
Communicating with Your Mount When Writing Your Own Programs	71
RS-232 Port Settings:	72
Command not functional	72
Appendix B: RS-232 Command Language - Firmware Version G	73
General Telescope Information:	73
Telescope Motion	74
Position	77
Miscellaneous	78
Communicating with Your Mount When Writing Your Own Programs	79
RS-232 Port Settings:	80

Appendix C: Common Stars – By Constellation	81
Appendix D: Alphabetical Star List	88
Appendix E: Constellation Abbreviations	94
Appendix F: Common Object Names	95
Appendix G: Aitken’s Double Star (ADS) List	96
Appendix H: The Greek Alphabet	99
Appendix I: Menu Layout	100

# GTO KEYPAD CONTROLLER

The GTO keypad controller is the communication center for the operation of your GTO mount. We have designed this unit to be as intuitive and easy to use as possible while filling it with terrific features to make your observing session productive and pleasurable. With a few keystrokes, you can slew to objects by their common name or catalog number, set up search parameters to find all the open clusters (in the Messier catalog) that are visible on a given night, focus your telescope for astrophotography, set the countdown timer for the exposure, enter RA and Dec coordinates to find the newest super nova, and much more.

The heart of the controller is the 4-line display screen that will guide you through all operations. The alphanumeric keypad itself is translucent and backlit with red LEDs for easy visibility at night. The buttons are also made with a phosphorescence material that will glow in the dark for a brief time.

Button functions are clearly defined on the button itself or as an instruction on the display screen. You do not have to remember shift key patterns or complex keystroke sequences. The directional buttons are shaped like arrows to help you find them in the dark without looking at your keypad. The stop button is readily accessible if you need to cancel any slewing request immediately.

The menu system is very easy to navigate. Each screen will display several choices, which correspond to a number button. Simply press the number button to initiate the command, e.g. "1=M, 2=NGC". When you press "1" the Messier entry screen will display and you can enter the number of the object that you wish to see. Press GOTO, which will cause the mount to slew. The <PREV and NEXT> buttons will allow you to scroll quickly through the lists of common names or to find more data about the object you are viewing. To adjust most settings, you will press the number indicated on the screen several times to scroll (toggle) through your choices and stop at the one you want.

We suggest that even if you plan to slew to various objects using a computer program on a PC, you should use the keypad controller for your initial polar alignment/calibration routine. This will provide your mount with essential data regarding your location and time and will allow you to polar align with ease.

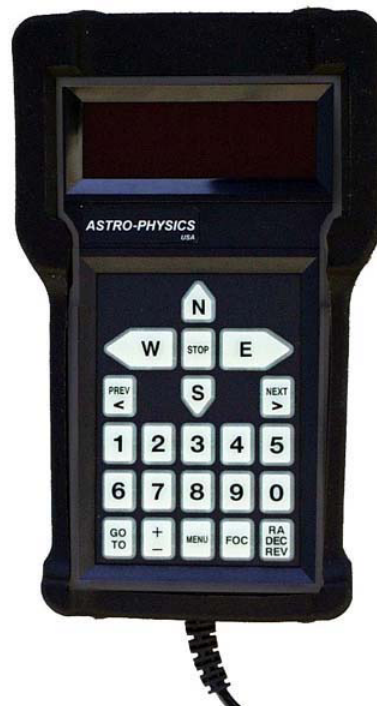

GTO Keypad with Keypad Protector

## Layout and Buttons of the Keypad

### Vacuum Fluorescent Display

The keypad features a four-line, 20 character alphanumeric display. The brightness of the display is adjustable with "dim" and "bright" settings. Please refer to the section entitled "Brightness of the display screen". If you are using the keypad in the daylight, you will need to shade the screen from the direct light with your hand in order to see it more clearly.

### N - S - E - W Directional Buttons

These four buttons are arranged so that the "E" and "W" buttons control the movement in right ascension and the "N" and "S" buttons control the declination. This is the "normal" orientation of objects in the eyepiece field. When you press the "N" button, the star should move in an upward direction toward the top of your eyepiece field. In addition, you can press two buttons simultaneously for diagonal movement, e.g. the "N" and "W" buttons will cause a "NW" movement.

### RA/DEC REV Button:

Press the RA/DEC REV button to access these functions, then press menu to exit from this screen. This button serves several functions:

- **Reverse RA/Dec:** If the star moves down when you push the "N" button, press the RA/DEC REV button in the lower right corner of the keypad. A reversing menu will appear on the screen. If you want to reverse direction of the "N" and "S" button, press "1" on the keypad and the display will change from

RA/DEC Reverse Screen

1=Rev RA :Normal  
2=Rev DEC:Normal  
9=Re-Calibrate  
Meridian < 0W >

“normal” to “reverse”. You can make the same adjustment with the “E” and “W” buttons. When properly set up, the direction buttons will cause the object to move according to your orientation at the eyepiece.

- **Re-Calibrate:** If you wish to tweak your pointing accuracy, slew to an object, use the N-S-E-W directional buttons to center the object, then press the RA/DEC REV button and select #9. This will recalibrate your mount. Refer to the section later in the manual that for more detailed information.
- **Meridian Delay:** Advanced astro-photographers will appreciate this feature. Refer to the section of the manual that discusses Meridian Swap. Do not change this setting unless you understand the consequences.

## STOP Button

Press the STOP button to cancel a slewing command and stop the movement of the telescope immediately. The mount will know where it is, so you can proceed to your next command. If you move the telescope by hand, you must follow the recalibration procedure.

## Number Buttons

The buttons labeled 1-9 and 0 are used to enter numerical data and to make menu choices.

## <PREV and NEXT> Buttons

These buttons are used for the following functions depending on the commands you are entering: move from one menu level to another, backspace to make corrections to number entry or scroll through lists of objects. The “<” and “>” symbols appear on many screen displays. They signify that you can press the <PREV and NEXT> buttons for more choices or additional information. These buttons are also used in conjunction with the FOCUS button as described below.

## GOTO Button

Press the GOTO button after you have selected the object that you want to view. The mount will slew to the object. This button is also used for other functions, i.e. saving location data.

## + - Button

This button has two different functions.

- Use it to toggle between “+” and “-“ when entering RA and Dec coordinates.
- To change the rate of the N-S-E-W directional buttons, press the + - button to display a selection screen. Use the <PREV and NEXT> buttons to scroll through the rates. Also you can change the ‘A.’ guiding speed on this menu as well by pressing the #7 button to scroll through the rates. These features can be accessed whenever the N-S-E-W buttons are active.

## MENU Button

Press this button to move to a previous menu level or to cancel a prompt.

## FOC Button

To use this function, you must have an electric focus motor (available from JMI, Meade and others) plugged into the GTO Control Panel and the corresponding attachment to your focuser. Hold the FOCUS button with one finger and press the <PREV and NEXT> buttons to change focus. You can change the speed of the focus adjustment to either “High” or “Low”. Please refer to the Focus Adjustment section for further information.

## Retractable Hanger

On the back of the controller, look for a slot with a thumb rest area. Push up to extend the hanger. A length of lightweight cord can be attached here to allow you to hang your keypad on one of the base knobs of the pier when it is not in use.



## **Keypad Protector**

The keypad protector (part # KEYPRO) is highly recommended. Although originally sold as an optional accessory, it is now included with every mount and keypad purchase. The keypad protector is a heavy-duty molded rubber casing with a full 1/4" thickness on all impact surfaces. If you accidentally drop your keypad, the rubber casing will absorb much of the blow. Your display, keypad, electronics and the case itself will be protected from damage. In addition, the rubber prevents the keypad from sliding when placed on a table or other flat surface and the keypad will feel secure in your hands as you observe. The KEYPRO also offers protection during transport and storage.

### **Installation:**

Caution: The KEYPRO fits closely around the keypad controller. You must work it gently into place. If you force the rubber casing while it is being installed on your keypad, you may tear the rubber.

1. Insert the connector and thread the cable through the opening at the bottom of the KEYPRO. Do not insert the cable and the bottom of the keypad all the way at this time.
2. The first part of the keypad inserted is the top portion with the display.
3. Gently work the bottom portion including the cable connection into place.

## **Keypad Care and Warranty**

### **Warranty**

Keypad: Three (3) years parts and labor.

Battery: 90 days.

The keypad manufacturer warrants that the product is free of defects in materials and/or workmanship from the date of shipment for a period of three years. This warranty does not apply to any products which have been subject to misuse, accident, alteration or if the unit has been serviced by anyone other than an authorized representative. During the warranty period, the manufacturer will, at its discretion, (1) repair the product to full working order; (2) replace the product with a comparable product. Replacement products will be new or serviceably used, comparable in function and performance to the original product. The product will be warranted for the remainder of the original warranty or ninety (90) days from the date of shipment of the product, whichever is longer.

### **Keypad Battery for 256K Memory Boards**

Keypads with serial number 1490 or below that have the original 256K circuit board have a 3V Lithium battery that powers the memory so that information is retained from one session to the next. Battery life is estimated 5 years at room temperature. If the battery fails within the 3-year warranty period, the manufacturer should replace it or the warranty on the remainder of the unit could be voided.

You can purchase replacement batteries from Astro-Physics, our part # E0310 or alternate sources. Instructions for replacement are in the Technical Support section of our website. Dispose of used batteries according to battery manufacturer's instructions.

Battery Manufacturer: Renata

Battery Number: CR1632

### **Keypad Battery for 512K Memory Boards**

This includes keypads with serial number 1491 or later and earlier keypads that have been repaired or upgraded with a new 512K memory board. These keypads also have a 3V Lithium battery with an estimated life of 5 years at room temperature. However, this battery has been wired into a special assembly, so the replacement must be purchased from Astro-Physics, but it can be installed by the customer. If the battery fails within the 3-year warranty period, the manufacturer should replace it or the warranty on the remainder of the unit could be voided since you have opened it.

If you are unsure which battery you have (for instance, if you purchased a previously-owned mount), give us a call and we can help you find out.

### **Cleaning Keypad Display**

The display window is made with a Mylar material. It is recommended to use a commercial glass cleaner to wipe down the display. Spray the cleaner on a cloth and rub the display lightly. Do not use solvents of any kind.

***Temperature Ratings***

The real time clock, battery-backed RAM, Extended Temperature Vacuum Fluorescent display, and backlit panel are all rated to –40 degrees C (-40 degrees F).

# NEW FEATURES OF VERSION 4.12

Version 4.12 the keypad is a major upgrade from v2.6 and v3.09, incorporating the suggestions offered by our customers. The following is a summary of the new features implemented since v3.09. Please refer to the appropriate sections of this manual for detailed information. In addition, refer to the technical support section of [www.astro-physics.com](http://www.astro-physics.com) for information about previous version features that are in this firmware and possible future updates to this manual.

The ROM chip in your GTO servo control box must be dated later than January 22, 2001 to enable and to utilize all the features in version 4.12 of the keypad. You can check this by removing the cover of the GTO control box and checking the date written on a label attached to the ROM chip. Please contact Astro-Physics if you need to order a new chip.

All previous keypads have sufficient memory capacity for version 4.12.

## 09-06-04 Version 4.12

- **GMT and LST issues for E longitude.** Fixed bug. Keypad now interprets correctly all E longitude data when polling the mount for location, time and time zone data.
- **Set Date & Time.** Fixed bug that caused LOC:-3 display in 4=Time/LST and error message when Set Date & Time screen was selected under certain circumstances.
- **Auto-Connect set to YES.** Fixed bug. Locations 2-9 will Auto-Connect correctly.
- **Reset Command.** The keypad will reset all user-defined values to the default setting of 0 in real time.
- **Error checking in Site Location Data screen.** Only N-S-E-W values will be accepted. If incorrect, an error message will appear.

## 08-28-04 Version 4.11

- **Resume from Park.** Fixed bug. Now works properly.
- **Site Location Data screen.** Changed name from Set Site Location to more clearly define its function. Also fixed bug. If you press MENU when exiting Site Location Data screen, it will not impact the location display of 4=Time/LST screen.
- **Sync command in Messier, NGC and IC input screens.** The Sync command was removed from this screen since it was not valid. You must press >NEXT twice to enter the Sync command screen.

## 08-26-04 Version 4.10

- **Syncing on Planets.** This version now allows you to synchronize on the Sun, Moon, Venus, Mars, Jupiter and Saturn. Press the <PREV button to take you back out to the Sol Menu if you entered from it.
- **Default display of RA/DEC co-ordinates in Objects screen.** Press the <PREV button to display the object data on this screen. This increases the speed of the keypad and allows the function of the N-S-E-W buttons in more places.
- **Sync on almost any object, before or after moving to the object.** To sync on the object currently selected press the NEXT> button. This is now common for all objects in all menus.
- **Fixed a minor bug in the resumption of tracking after parking the mount.** The mount now tracks at whatever speed was last selected when coming out of park.
- **PEM display now automatically changes to PLAY after recording.** Fixed condition that required you select PLAY manually.
- **The meridian delay is saved but automatically resets to 'zero' after the mount is restarted.** This allows the mount to know where it is when the session starts, but forces you to set up the meridian delay for each session to prevent unintended consequences.
- **Stars heading after selecting the star has been changed to 'Objects:'.** This change has been made due to the addition of planets to these screens. Planets are obviously not stars.

- **Re-Calibrate command.** Fixed bug. The keypad now sends the proper re-calibrate command from the RA/DEC/REV menu.
- **RA/Dec Readout.** Fixed bug. N-S-E-W buttons will work correctly.
- **Keypad Update Menu added.** This new menu is found under the Keypad Options menu. It allows you to update the keypad database without losing your personal settings. It is now possible to reset back to the factory default settings. In prior versions, this was a one-part command that reset the keypad whenever the database was loaded (this was only done at Astro-Physics, it was not available for internet download at the time). Now, there is a two-part menu that allows you to maintain your personal settings when re-loading a database (this will be handy for future additions to the object databases) or you can reset your settings back to the defaults without having to shut down your mount (handy if you purchase a used mount and wish to remove prior settings in order to enter your own).

## 02-16-04 Version 4.07

- **Re-designed menu system.** Startup and setup displays have been re-designed for easier use and access. Other displays are totally new. Please look through all of the menus to make note of the changes before you go out observing.
- **Full cursor control in all entry areas.** The keypad's cursor can be moved backwards and forwards with the <PREV and NEXT> in all of the areas where data is entered. Great for fixing any mistakes you make without having to start from the beginning again. This feature will be especially handy for time and location settings. When you hit the last column of entry data the cursor will move back to the start. You must press GOTO to save or to run your entry or MENU to exit from the screen.
- **All entry screens will only enter or save when GOTO is pressed.** Also pressing MENU will exit you from any screen with the entered data being lost. Adds built in confirmation of all entries.
- **Saved variables.** The keypad will now store the important user variables, tracking, slewing and guiding rates and other settings, after it is shut down or unplugged.
- **Four button (N-S-E-W) + Stop.** Now available throughout the keypad, in all menus, object screens and most input areas.
- **Guide speed / button speed settings.** Separate settings for external auto-guider operation and button speeds. Auto-guider settings of .25, .5, 1x are now independent of the button speed settings.
- **+/- Button.** Now permits auto-guide value to be changed on this menu as well.
- **Start from Reference Park.** This allows you to start the mount in the field by placing the telescope in Park1 position for quick daytime polar alignment.
- **External auto connect.** Now you can start the servo from an external computer and send time, date and location from that source at startup without having to unplug the keypad each time. This insures that the keypad, mount and computer will all be synchronized with each other automatically. The keypad will go directly to the Main Menu as soon as the external program initializes the mount. All values of time, date and location will be transferred to the keypad. The keypad can then be used in the normal manner at any time.
- **SmartGuide control.** Adds variable speed capability to both axes. Designed to null out drift during unguided exposures. Great for tracking slow-moving, non-sidereal objects such as lunar craters, comets and asteroids.
- **Get time and location from mount.** You can now ask the mount for the time and location and set that value to the keypad. This value could be sent to the mount via your external computer program. This allows the mount, the keypad and external computer to all be in sync.
- **9 Locations.** Longitude, Latitude and time zone now can be set to 9 different places. We suggest noting them on a piece of paper on the back of your keypad so that you can keep track of them all.
- **Altitude/Azimuth display.** Added to real-time RA/DEC display. ALT/AZ values change as mount is moved in RA/DEC directions. With tracking rate set to zero, mount can be positioned for fixed targets to any Alt / Az point.
- **Altitude/Azimuth input.** This new option allows you to slew to any position in the sky as long as you know the Altitude and Azimuth angles.

- **New local horizon limit setting** Useful for keeping your telescope from slewing to objects below your observing site's horizon.
- **Audible feedback with Re-calibration command.** You will now hear a beep when you re-calibrate the mount to confirm that the operation is complete. Re-Calibrate has also been removed from the objects menu. It is still located in the RA/DEC/REV screen 9=Re-Calibrate.
- **What's Up Now.** Tied to horizon limit as well using the M, NGC, and IC databases of objects in the keypad. What's up Now function will suggest objects to view based on what is actually above the horizon at the time 'What's Up' is requested.
- **Auto initialization routine.** Detects when new firmware is loaded to the keypad and if saved values need to be re-initialized. This new 'power on' routine will now auto-decide if the keypad needs to be re-set to factory defaults when new saved values are added. When a new future release of the code is loaded into the keypad, the user will no longer have to manually reset all his/her custom keypad settings, i.e. locations and daylight savings.
- **Full error checking.** added to Location, Date/Time, RA/DEC, Alt/Az entry - with notification if entry is not valid. Will not allow impossible settings.

### **Features from version 3.2 (3.2 was only shipped with new mounts or repairs)**

- **Sun warning.** A warning display shows when you request an object or RA/Dec position that is within 15 degrees of the sun. The warning will not display during the park function.
- **Database level and program code level display.** This feature allows you to check your database and code version number. In order to update or download the database from the Internet (feature available soon). Only version numbers 3.2 or higher will display.

# GETTING STARTED - DO THIS AT HOME, IF POSSIBLE

## Setup your Mount and Cable Connections

Refer to the instructions in the mount assembly manual to set up your mount. The following cables must be connected: RA and Dec cables, and keypad controller cable and power cable, preferably in that order. You do not need the mounting plate or telescope tube assembly for these setup procedures.

## Gather Basic Information

You will need to enter your local parameters to ensure that the mount functions properly. The mount needs to know the local time (and if you are on daylight savings) and the longitude and latitude of your observing site. In fact, you can enter up to nine observing sites to be stored in memory.

To determine your longitude and latitude, consult your atlas, topographical or automobile maps. The Internet also has a number of resources for finding your longitude and latitude. A GPS unit may also be helpful. The closer you can get the better, however, it is not necessary to be exact to the seconds (last two number entry fields) since the purpose of these entries is to calculate which objects are above your local horizon. Please make sure that your location information is in Degrees:Hours:Seconds format (ie: 42:22:00 Lat. 89:01:07 Long.) rather than Decimal format. (ie. 42.3667° Lat. 89.0186° Long)

The time zone is determined from the Greenwich meridian. An excellent reference is the Standard Time Zones chart in [Norton's 2000.0 Star Atlas](#). The Keypad will automatically determine if you are east or west of the Greenwich meridian so entering a positive or negative number is not needed. If you live in the eastern hemisphere and observe daylight savings time, please consult "Using the Keypad and The Sky Together" for special instructions about your time zone. For your reference, these are the US time zones.

US Eastern standard time	05
US Central standard time	06
US Mountain standard time	07
US Pacific standard time	08
US Hawaii standard time	10

Most of this information will be entered only once and will be remembered by the keypad. We recommend that you make these entries at home before you go to your observing session to ensure that you have the information that you need. If you have a GPS (Global Positioning System) device, you may want to enter the coordinates once you reach your site and have the proper numbers.

## Enter Your Location, Date and Time

1. If the Location Selection Screen appears the first time you start up your mount, press 1 and GOTO, then proceed to step 2. If the Main Menu appears, begin these instructions with step 3.
2. Select option 3=Resume From Park, which will allow you to bypass this screen.
3. Main Menu should now be on the display. You will need to enter all of your Location, Time, Daylight savings and Date settings whether this mount is new or has been upgraded to v4.12.
4. DO NOT ATTEMPT TO SLEW TO ANY OBJECTS AT THIS POINT. You must first setup your location and time as described below and follow the instructions for Your First Observing Session.
5. Go to Keypad Options selection screen (Main Menu → Setup → Keypad Options). The top line displays 1=Auto-Connect. Press "1" to toggle to NO if it is not set to NO already.
6. Press Menu to go back to the Setup Menu.
7. Press 1=Locations & Time. Then, select 1=Site Location Data
8. You will now be presented with the Location Selection screen with locations 1-9 available.

Location Selection Screen

**Location Selection**  
Enter number, then  
Press GOTO to select  
Location <1-9>:

Sync, Align, and Resume Menu

**1=Star-Sync**  
**2=Polar Alignment**  
**3=Resume from Park**  
**4=Resume Ref-Park 1**

Main Menu

**1=Object**    **5=S:1200**  
**2=Setup**    **6=B:600**  
**3=Tools**    **7=A:1**  
**4=Time/LST** **8=T:Side**

Setup Menu

**1=Locations & Time**  
**2=Mount Move Limits**  
**3=Keypad Options**  
**4=Park / Mount Opt.**

9. Choose location 1 by entering #1 and pressing GOTO. We recommend that you set location 1 to the site that you observe from the most. Enter your Longitude, Latitude and Time Zone settings. If you do not wish to change the settings that are already entered, press the GOTO button to return to the Locations & Time menu. After you have entered the information, you **MUST** press GOTO to save your data and return to the Locations & Time menu. If you made a mistake, just use the <PREV and NEXT> keys to move back to it and fix it. The keypad will beep when you exit to indicate that the data is saved.
10. If you wish to enter more locations (up to 9 different sites are available), please do the previous step again; changing the number for each location you enter. We suggest that you write the location number and a brief description on a piece of paper and tape it to the back of the keypad to aid your memory.
11. After your location settings are complete, enter your time, date and daylight savings settings.
12. Press 2=Set Date & Time on the Locations & Time menu. Enter the correct time, date, and current daylight savings settings, for your current location. If you made a mistake just use the <PREV and NEXT> keys to move back to it and fix it. If the settings are already correct, press the GOTO button to return to the Locations & Time menu. To save your changes you **MUST** press GOTO to return to the Locations & Time menu. The keypad will beep to confirm your entries. Pressing MENU will exit the screen with the changes unsaved.
13. After you have completed ALL of the above entries, turn off the power to your mount for 10-15 seconds.
14. If you wish to practice with your keypad, refer to the next section. If you are set up at your site and are ready to observe, proceed to the section entitled "Your First Observing Session".

#### Locations & Time Menu

**1=Site Location Data**  
**2=Set Date & Time**  
**3=Get Time/Loc FrMnt**

#### Location Input Screen

**Long: W 000:00:00**  
**Lat : N 00:00:00**  
**Time Zone :00**

#### Time & Date Input Screen

**TIME: 21:12:38**  
**DATE: 05/15/2003**  
**Daylight Saving: 0**  
**1=Summer 0=Winter**

#### Star Selection Menu

**Choose Star Z=05:54**  
**1=Polaris <**  
**2=Acamar**  
**3=Achernar >**

## Practice Using your Keypad

You may want to try out your keypad while the mount is set up at home. We suggest that you don't put the mounting plate, counterweights, counterweight shaft or telescope on the mount since you won't be truly polar-aligned and calibrating precisely. If your telescope is attached, you may cause it to hit the pier. Read the following instructions as you use your keypad to simulate an observing session.

1. Physically move your mount to the park 1 position as shown in the photo. Set both axes to be level with the ground. Although a bubble level would be important in a real observing session, for this purpose, a rough position is fine.
2. When you plug in the cable of your keypad, the words Astro-Physics and the version number of the firmware will appear briefly. Then, the Location Selection screen will display since you have set Auto-Connect to NO in the procedure above. Please select your location by entering the desired number and press GOTO.
3. From the next screen, select 4=Resume Ref-Park 1. The mount now knows that it is in the Reference Park 1 position (both axes parallel to the ground). With this information, you can reasonably simulate an observing session.
4. Proceed to the information on the Objects Menu or other topics of interest as discussed later in the manual.
5. When you are finished with your session, be sure to leave your keypad in the Auto-Connect NO setting.

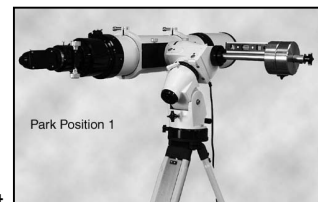

#### Sync, Align, and Resume Menu

**1=Star-Sync**  
**2=Polar Alignment**  
**3=Resume from Park**  
**4=Resume Ref-Park 1**

## **YOUR FIRST OBSERVING SESSION WITH V4.12**

These instructions apply to new mounts, keypads that were just upgraded to this version or if you installed a new micro-controller chip in your control box.

In order for your mount to operate properly, it must have basic information: location, date, time, time zone and daylight savings. This information must come from an external computer source, i.e. the keypad. These instructions assume that you have entered this data into your keypad per instructions in the preceding section. Now, follow the procedures in the next section entitled: "Normal Startup Sequence."



# NORMAL STARTUP SEQUENCE - FOR MOUNTS THAT ARE SETUP IN THE FIELD

If you are setting up your telescope in the field at a new location, you will have to use the normal startup procedure in order to provide your mount with essential information: location, date and time. Auto-Connect must be set to NO. Additional information regarding the YES and EXT Auto-Connect selections is provided in later sections.

## Assemble Your Mount

Refer to the instruction manual for your mount to set up at your observing site. Aim the polar axis toward Polaris (or the southern celestial pole) as closely as you can by sighting up the hole in the center of the polar axis or along the axis. You may find our Polar Alignment Telescope (PASILL3) a useful accessory for quick and easy setup. The more accurately you polar align, the more accurate will be the centering of objects in a high-power field-of-view. Be sure that you connect your RA and Dec cables, keypad cable and power cable, preferably in that order.

## Startup sequence

1. When you turn on the power, the first display of the keypad will briefly read "Astro-Physics" and then version number. The Location Selection Screen will then display.

**Note:** If the Main Menu screen appears, that means that the Auto-Connect feature is set to "yes." Set the Auto-Connect feature to "NO" by selecting Setup and then 3=Keypad Options. Press "1" to toggle Auto-Connect to NO. Then turn power off, wait 10-15 seconds and on again.

2. Choose location 1-9 and press GOTO. The next menu has 4 choices: Star Sync, Polar Alignment, Resume from Park, and Resume Ref-Park 1. If you click on Polar Alignment, you have two choices: N Polar Calibrate and 2-Star Calibrate. Each of these is described below.

**Important:** We don't allow the user to back out of the startup routine (press Menu button to return to the previous screen) in order to prevent errors in the calibration process. It was possible to back out in the early versions of the keypad, however users erroneously thought they were calibrated when they were not. So, we force completion of this routine. If you enter information, then decide to change it, simply turn the power off, wait 10-15 seconds, then turn it back on again. This will start the process again.

## Star Sync

Choose Star Sync if you are properly polar-aligned by one of the other methods (polar scope, star drift, etc). Aim the scope at a known stellar or solar system object (at the end of the star list). If you need to change your button-centering rate, use the + - key to do so. Scroll through the list to find the object, enter the object number, press the GOTO button (the mount will not actually go anywhere) and you are synchronized. The Main Menu will appear. You are now ready to enter any object from the Object Menu or go to the Setup Menu to make changes, as needed.

**Very Important:** You must point to stars in the west when your telescope is on the east side of the mount and stars in the east when your scope is on the west side. When the stars are high and close to the zenith, this can be tricky. However, you can tell which side the star is on by looking at the "z" number in the upper right corner of the Choose Star screen, then comparing that number with the RA number of the star you choose. If the RA number is larger, the star is in the east. If your scope is not on the correct side, the mount will not slew properly and the telescope could strike the pier/tripod.



## Polar Alignment – Which method to choose?

Choose Polar Alignment if you wish to use the alignment routine built into the keypad. You have 2 choices, N. Polar Calibrate and 2-Star Calibrate.

<p><b>Calibrate Menu</b>  <b>1=N Polar Calibrate</b>  <b>2=2 Star Calibrate</b></p>
---

For most situations, we recommend the 2-star calibrate routine since it typically yields better results. Using Polaris as one of your calibration stars may result in your polar alignment being off if your scope is not orthogonal to the mount (read the section “Orthogonality” to understand this concept). For instance, if your scope points 1 degree north or south of the polar axis, and you use the N-Polar calibrate routine, you may be off by as much as 5 hours in RA on Polaris.

If Polaris is not visible from your observing site or if you are in the Southern Hemisphere, you will also use the 2-star alignment routine.

You need to be roughly polar-aligned for both procedures. The closer you are to polar alignment when you start, the faster this procedure will be.

These two routines are designed to help you mechanically align the mount axes to be parallel to the Earth’s rotation. They are NOT designed to compensate for a nonpolar-aligned mounting and a telescope optical axis that is not orthogonal to the mechanical axis. How accurately you can ultimately align your mount depends on how well you choose your Calibration stars (the farther apart the better), how accurate the orthogonality of the telescope optical axis is to the mount’s mechanical axis and how many iterations are done.

How accurately you need to be polar aligned is governed by your needs. If you wish to do some quick visual observing with low-power, wide-field eyepieces, you don’t need to spend a lot of time aligning (see “How to Find Objects if You Have Less than Perfect Polar Alignment”). If you need accurate alignment for CCD imaging or high-power observing, you may want to use a Polar Alignment Scope (PASILL3) and follow-up with a comprehensive drift alignment. Refer to the Alternate Polar Calibration Routine and Tips section.

<p>ORTHOOGONALITY - If you have difficulty achieving accurate polar alignment with the procedures below, refer to the section entitled “Orthogonality.”</p>
---

## N Polar Calibrate - Calibrating with Polaris

This routine uses a known star in the eastern or western sky and Polaris to align the mount. Since you are essentially using your telescope as a polar alignment scope in this routine, it is very important that the telescope be orthogonal to the mount. If it is not orthogonal, the stars will not converge no matter how many you use.

Try to pick a star that has a sufficiently different (+or - four hours) right ascension from Polaris, otherwise this method may not converge on the pole in a reasonable number of iterations. For instance, the star Arcturus is close in right ascension to Polaris and so would not be a good candidate. Arcturus is roughly 12 hrs different in RA from Polaris or 180 degrees opposite and close to the meridian in the south. So when the mount slews between Polaris and Arcturus, it only has to move a small amount in RA – about 45 minutes. Not a good choice. Also avoid any stars with the same RA as Polaris.

1. **Check position of mount.** Be sure that the polar axis is pointed as close as possible toward Polaris (the North Star). If not, make these adjustments now. Follow the procedures to select your location in the previous section.
2. **At the Cal. Menu, choose N Polar Calibrate.** The Choose Star display will appear. In the upper right of the screen, you will find the zenith hour displayed (e.g. Z=17:17). Zenith hour is synonymous with LST (local sidereal time). This allows you to open your star atlas to the page corresponding to the sky overhead to aid in your calibration star selection.
3. **Move telescope manually (grasp the telescope by hand and move it) to a known bright star, which will be your calibration star (Vega in this example) and center it in the eyepiece field with the N-S-E-W directional buttons.** We recommend that you use a crosshair eyepiece.

Star Selection Menu

<b>Choose Star</b>	<b>Z=05:54</b>	
<b>1=Polaris</b>		<
<b>2=Acamar</b>		
<b>3=Achernar</b>		>

**Very Important:** You must point to stars in the west when your telescope is on the east side of the mount and stars in the east when your scope is on the west side. When the stars are high and close to the zenith, this can be tricky. However, you can tell which side the star is on by looking at the “z” number in the upper right corner of the Choose Star screen, then comparing that number with the RA number of the star you

choose. If the RA number is larger, the star is in the east. If your scope is not on the correct side, the mount will not slew properly and the telescope could strike the pier/tripod.

4. **Select that star on keypad.** Use the <PREV and NEXT> buttons to scroll through the star list to find the star you have chosen. Select this star by pressing the corresponding number. The RA and Dec values of the star will be displayed. Please note that the LST (local sidereal time) values for your screen will be different than shown in these examples. If you have made a mistake, use the <PREV button to choose another star. There are 200 calibration stars from which to choose. Note: although the solar system objects display in the star list, you cannot use them in these calibration routines. Since the RA/Dec positions of these objects change with time, they are not suitable for slewing back and forth in multiple iterations. Do not use the solar system objects.

Calibrate Star Screen

< Cal Star: Vega >	
RA :18:36:56	
DEC:+38:47:01	Press
LST:13:43:49	Goto

5. **Press the GOTO button.** The scope will automatically slew to Polaris which should appear somewhere in the field of a low to medium power eyepiece. This will depend on how close your “rough” polar alignment is.
6. **Center Polaris with the altitude and azimuth adjusters of your mount.** Please refer back to the mount instructions. Do not use the N-S-E-W buttons to center Polaris.

Center Polaris Screen

<b>Center POLARIS in eyepiece with Alt/Az Goto to re-calibrate Next to Exit Cal. &gt;</b>	
---	--

If Polaris is not in the field at all, you will need to make larger adjustments to the position of your mount. Be sure that the RA axis is pointing as close as possible to the northern celestial pole.

7. **Exit the calibration routine, or continue for more accurate alignment.** Remember, the more accurate your polar alignment, the more accurate your final pointing accuracy will be.
8. **To continue calibration, press GOTO again.** The star list containing the previous calibration star will display for your convenience. The mount will not slew; you are simply indicating that you wish to continue.
9. **Select the same calibration star or choose a different one from the Choose Star display.**
10. **Press GOTO.** The mount will slew to the star you have chosen.
11. **Center the star with the N-S-E-W buttons.**
12. **Press Menu.** The mount will slew to Polaris again.
13. **Make the altitude and azimuth adjustments to center Polaris as before.**
14. **Repeat as needed.** You can repeat this procedure any number of times until you feel that the mount is properly aligned. Each iteration should bring you closer to polar alignment.
15. **Press NEXT>.** Now that you are polar aligned, press the NEXT> button. The Main Menu will display and you are ready to observe.

## Two-Star Calibration

If Polaris is not visible, you will use the 2- star method. The accuracy of your alignment will depend on how orthogonal the telescope is to the mount axes (refer to the “Orthogonality” section later in the manual).

If your tube assembly is not orthogonal, stay within + - 60 degrees of the celestial equator when doing a polar alignment routine. Select two stars on one side of the mount during calibration. When you are using the mount to slew to objects and it flips to the other side, use the procedure discussed in the section entitled “How to Find Objects if You Have Less Than Perfect Polar Alignment” below.

Star Selection Menu

<b>Choose Star</b>	<b>Z=05:54</b>
1=Polaris	<
2=Acamar	
3=Achernar	>

1. **Set up your mount so that the RA axis is pointing to the celestial pole as closely as you can.** Refer the instruction manual for your mount.
2. **At the Cal. Menu, choose 2-Star Calibrate.** In the upper right of the Choose Star screen, you will find the zenith hour displayed (e.g. Z=15:43) this allows you to open your star atlas to the page corresponding to the sky overhead.
3. **Decide which star in the eastern sky to use as your 1st calibration star.** There are 200 calibration stars and all solar system objects from which to choose, e.g. Antares. Note: although the solar system objects display in the star list, you cannot use them in these calibration routines. Since the RA/Dec positions of these objects change with time, they are not suitable for slewing back and forth in multiple iterations. Do not use the solar system objects.

4. **Move telescope manually (grasp the telescope by hand and move it) to the star and center it in the eyepiece field with the N-S-E-W directional buttons.** We recommend that you use a crosshair eyepiece.

**Very Important:** You must point to stars in the west when your telescope is on the east side of the mount and stars in the east when your scope is on the west side. When the stars are high and close to the zenith, this can be tricky. However, you can tell which side the star is on by looking at the “z” number in the upper right corner of the Choose Star screen, then comparing that number with the RA number of the star you choose. If the RA number is larger, the star is in the east. If your scope is not on the correct side, the mount will not slew properly and the telescope could strike the pier/tripod.

5. **Select that star on keypad.** Use the <PREV and NEXT> buttons to scroll through the star list to find the star you have chosen. Select this star by pressing the corresponding number. The RA and Dec values of the star will be displayed. Please note that the LST (local sidereal time) values for your screen will be different than shown here. If you have made a mistake, use the <PREV button to choose another star.

Calibrate Star Screen

```
< Cal Star: Regulus >
RA :10:08:22
DEC:+11:58:01 Press
LST:12:26:16 Goto
```

6. **Press GOTO.** This enters the star in the calibration memory. The telescope will not move. The Choose Star screen will come up again.

7. **Choose your second star,** ideally at least 6 hours difference in R.A and preferably 40 degrees or more different in Dec.(e.g. Regulus). Again, the Cal Star screen will appear with the coordinates of your star choice.

8. **Press GOTO.** The mount will slew to this star. The target star should appear somewhere in the field of a low to medium power eyepiece.

Star RA/DEC Screen

```
Star: Regulus
RA :10:08:22
DEC:+11:58:01
Menu=Exit >
```

9. **Center star with altitude and azimuth adjusters of the mount.** Please refer back to the mount instructions if needed. Do not use the N-S-E-W buttons to center the star. If the star is not in the field at all, you will need to make larger adjustments to the position of your mount.

10. **Press Menu to exit this screen.** The Choose star screen will appear.

11. **You may either end the calibration routine at this point, or continue for more accurate alignment.** Remember, the more accurate your polar alignment, the more accurate your final pointing accuracy will be.

12. **To end the calibration routine, press Menu again.**

13. **To continue calibration, choose the next star that you want to slew to.** You can chose a new star or go back to the first star. Again, at least 6 hours difference in RA and 40 degrees in Dec would be ideal, however you can also pick a star with less difference. You can go back to the original star you chose (e.g. Antares) or some other star that is visible in the sky The display will show the name of the star, RA and Dec coordinates and the LST.

Calibrate Star Screen

```
< Cal Star: Antares >
RA :16:29:24
DEC:-26:35:55 Press
LST:12:30:14 Goto
```

14. **Press GOTO.** The mount will slew to this star.

15. **Center the star in the eyepiece - half of the distance with the altitude and azimuth controls and the other half with the N-S-E-W buttons.**

16. **Press Menu to exit this screen.** The Choose Star list will appear again.

17. **Choose a star.** The Cal Star screen will appear with the coordinates of your star choice.

18. **Press GOTO.** The mount will slew to this star. The target star should appear somewhere in the field of a low to medium power eyepiece.

19. **Center the star in the eyepiece - half of the distance with the altitude and azimuth controls and the other half with the N-S-E-W buttons**

20. **You can repeat this procedure any number of times until you feel the mount is properly aligned.** Each iteration should bring you closer to perfect polar alignment.

Note: Each time you press the Menu button during this procedure, you re-calibrate on your current position.

## Resume from Park

Choose Resume from Park if you have previously parked the telescope after an observing session and have not moved the scope on the axes. The screen will advance to Main Menu and you are ready to enter objects or make changes in the Setup Menu.

## Resume Ref-Park 1

For this start position you will need to have a bubble level. Physically move your mount to the park 1 position by setting both axes to be level with the ground with the telescope on the west side of the mount. Use the bubble level to assist you. When the mount is in position, select this menu option. The Main Menu will display on the keypad so that you can proceed with your session. This option is particularly useful when using the Polar Aligning in the Daytime procedure described in the next section.

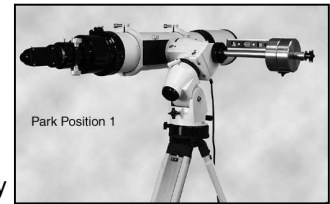

# ALTERNATE POLAR CALIBRATION ROUTINES & TIPS

The keypad is very powerful and offers a variety of ways to polar align and calibrate. The previous section discussed the most common as used in the Normal Startup Routine. However, there are other options, some of which are discussed below. You may even develop your own procedure using yet another method. This is probably more information than most users want to know, others will find it helpful.

## ***Polar Aligning in the Daytime***

***Using the Park 1 position to polar align your telescope in the daytime or when Polaris is not visible.***

### CALIBRATING IN THE DAYTIME

Before calibrating on the sun, you **MUST** install a safe, quality solar filter. Do not use eyepiece solar filters as they may break in the intense heat of the sun. When you are slewing to any object in the daytime, the telescope may slew across or very near the sun. **DO NOT** look into the eyepiece as the telescope slews. **DO NOT** attempt to view any object, e.g. Venus, when it is near the sun. Permanent damage to your eye may result if you look directly at the sun with your telescope. Refer to the section on “Slewing During the Day” for further information and warnings.

This is a great method in these situations:

- Solar observing.
- Get you up and running at a star party or observing site. You’ll have some fun pointing out the planets at twilight when the seeing may be steady.
- Get a head start on a night with a busy observing schedule. No more wasted time waiting for stars to appear to complete your setup.

The accuracy of this method depends on how accurate your keypad’s clock and your location has been set. Tests completed with an ordinary 7” carpenter’s level shows that the mount can be adjusted level to accuracy within 15 arc minutes. We used a Mayes brand “SUPER-CEDE” model that was purchased at a local hardware store. This level has a groove for accurate alignment on curved surfaces. It works well on both the counterweight shaft and the telescope tube.

### **1. Set Park 1 position.**

- a. Set up mount **WITH** the telescope and counterweights in a balanced state. Be sure that your clutches are loose so that the telescope will not slew to an awkward position.
- b. Point the mount roughly north; a compass would be handy. Remember magnetic north is not true north.
- c. Go through the keypad start-up routine.
- d. If auto-connect was set to “no”, select your location and press GOTO. Next select 4=Resume Ref-Park 1. This will take you to the Main Menu. Proceed to step 2.
- e. If auto-connect was set to “yes”, the Main Menu will appear right away.
- f. Enter Setup and enter the Park/Mount Opt. Menu.
- g. Select Park 1. The mount will slew. Ignore the direction the mount is moving, however keep an eye on your telescope to be sure that it does not slew into the tripod/pier. When it is finished slewing, it will put Park 1 into memory. You will need this later.

### **2. Manually move mount to Park 1 position.**

- a. Point the mount roughly north and approximately level both axes. Refer to the photo.

- b. Place a carpenter's level on the counterweight shaft and move the RA axis manually until the shaft is precisely level. This will place your mount in the Park 1 position.
- c. Tighten the R.A. axis clutches so that the axis cannot be moved accidentally.

**3. Set Park 2 position.**

- a. Enter Setup and go to the Park/ Mount Opt. Menu.
- b. Press Park 2. Wait until the scope has slewed to the Park 2 position.
- c. Using the bubble level, level the tube manually by turning the Dec axis only. Do not move the R.A. axis.
- d. Tighten the Dec clutches so that it cannot be accidentally moved.
- e. Press MENU to resume from park.

**4. Set Park 1 position and make altitude adjustments.**

- a. Press Park 1. Wait until the scope slews to the Park 1 position.
- b. With the carpenter's level, level the scope tube using the mount's altitude adjuster. Do not move the axes by hand.
- c. Press MENU to resume from park.

**5. Slew to object and make azimuth adjustments if needed.**

- a. Scroll back to the Main Menu.
- b. Enter Objects Menu and choose the object that you want to slew to. The mount will now slew to where the object is, assuming that the azimuth adjustment is correct (the mount is pointed exactly true north). These are some possible object choices.

- i. Sun - The sun is the most visible choice, of course, but you must exercise extreme caution when using this target. You must use a proper solar filter if you wish to image the sun in your eyepiece. Failure to do so may damage your optics and your eyes! If you don't have a filter, you can do this step with the dustcover on your scope (and finder scope) by observing the shadow of the tube on the ground. Another way is to line up the shadow of the front mounting ring on the rear ring. This is easy to do with Astro-Physics rings because the two corners on the top of the ring cast a sharp shadow.

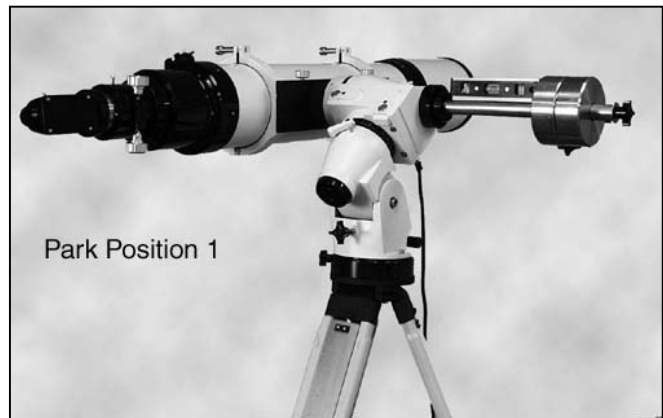

*Bubble Level on Counterweight Shaft*

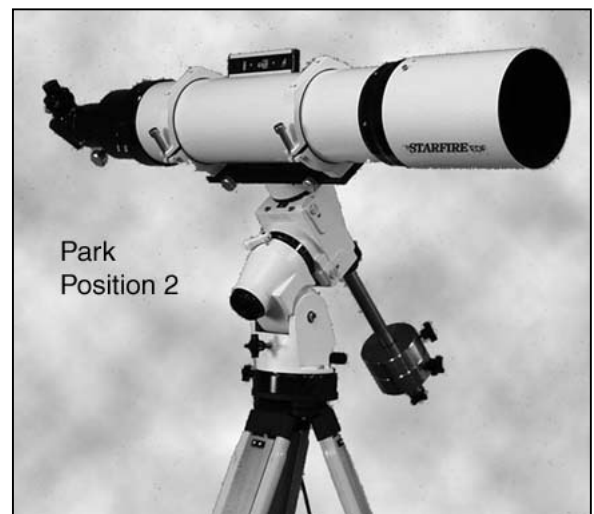

*Bubble Level on Scope Tube*

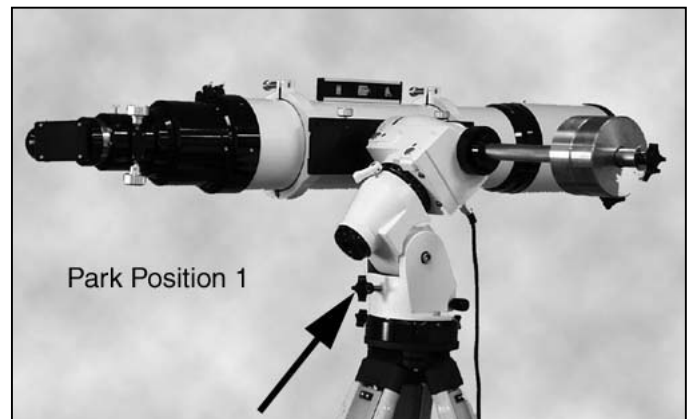

*Use altitude adjuster to level tube.*

- ii. Bright star or planet - You may also choose a bright star or planet if the sun has already set.
  - iii. Moon
- c. Make azimuth adjustments if needed. If the scope is pointed left or right of the object, simply turn the azimuth adjusters until the object is in the field.

While this method will get you close, it will not be accurate enough for critical astrophotography. You will have to align more precisely using other methods described below.

## ***GTO Quick Star Drift Method of Polar Alignment – Using the Meridian Delay Feature***

The star-drift method is the favorite way that astrophotographers align their mounts. After all, they would like the least amount of drift possible during their long time exposures. A go-to mount makes it possible to simulate this method without spending a long time waiting for drift to show up. It is also easy because it separates the two adjustments of altitude and azimuth. Use a crosshair eyepiece for this procedure.

1. **Follow one of the startup alignment procedures from earlier in the manual (one complete cycle) to get close.** You will be at the Main Menu when you finish.
2. **Slew to a star that is within 1 hour of the meridian, either east or west.** Be sure that your telescope is on the west side of the mount when pointing to a star in the east and vice versa. Center the star on the crosshair N-S-E-W buttons and press the RA/DEC/REV button then select #9 Re-calibrate option (from the RA/DEC/REV Menu).
3. **In the RA/DEC/REV menu look at the Meridian Swap selection.** If the star is in the west, advance the meridian by 1 hour so that the display shows Meridian<1W>. Use the PREV< and NEXT> buttons to advance the hour and also change the direction to either W or E (pressing PREV< multiple times will display the hours in the east). If the star is in the east, enter <1E> (You can verify if the star is in the east by it having a larger RA number than the current meridian or LST value). Press RA/DEC/REV to return to the Objects Menu.
4. **Enter the same star again and press GOTO.** Now the telescope will swap sides. The star will now appear again in the eyepiece, but may be displaced both in RA and DEC on the crosshairs.
5. **Make altitude adjustments.**
  - a) **The RA (east/west) error is a function of the orthogonality of the telescope.** For polar alignment, this can be ignored for now. Use the mount's altitude adjustment to bring the star half way toward the center of the reticle in the N-S direction. Center the star the rest of the way using the N-S buttons.
  - b) **Press the Recal button #9 again in the RA/DEC/REV Menu.** You will hear a beep letting you know you re-calibrated.
  - c) **Set the Meridian swap display to <0W>.**
  - d) **Enter the same star again and press GOTO.** The scope will again swap sides and acquire the star on the crosshairs. Repeat the mechanical alignment procedure until the star remains on or close to the crosshair. It is not necessary to do this at high power, nor is it necessary to get the star to fall exactly on the crosshair. 100x should be plenty of power – this is 12 times more sensitive than a typical polar scope.
6. **Make azimuth adjustments:**
  - a) **Pick two stars that are lined up in the east (or west) at similar right ascension values, but are separated by a large declination value.** In the winter, a good combination would be Beta Auriga and Alpha Orionis (Betelgeuse). In the summer, you can use Eta Ursa Majoris (the end star in the handle of the Big Dipper) and Alpha Virginis (Spica).
  - b) **Slew between these stars.** Again, using the GOTO, slew the scope back and forth between these two stars and adjust the azimuth axis of the mount to center each star in turn on the crosshair in the E-W direction (ignore any small N-S displacement). Remember to use the azimuth adjuster to correct half of the error and the E-W buttons to center the star.
7. When these two adjustments are finished, you will be very accurately polar-aligned. The accuracy of this procedure, as well as the N-Polar and 2-Star methods, depends on how well your telescope holds its



orthogonality. Any mirror shifting or diagonal misalignment (that applies to refractor diagonals as well) will not only compromise the polar alignment, but also the ability to accurately center objects when slewing from one to another. Please refer to the Orthogonality section for further discussion.

## ***Roland's Favorite Polar Calibration Routine***

This sequence follows a progression to finer and finer polar alignment. Only serious astro-imagers and photographers need to get to this level of precision. You can have lots of fun with your mount with the basic routines of the keypad or the methods in step one.

1. Any one of these methods can be used for the initial polar alignment. These will get you pretty close:
  - a) Above procedure for polar aligning in the daytime.
  - b) Polar alignment scope (PASILL3). Refer to the instructions with the polar alignment scope.
  - c) Keypad routines: N polar calibrate and 2-star calibration as described earlier in the manual.
2. Use the GTO Quick Star Drift Method using the Meridian Delay feature as described above. This will get you even closer.
3. Use CCDOPS to "drift align"  
Precision drift alignment can be achieved using the ST10 (or other) CCD camera and CCDOPS (You can do this with the STV also). This method uses the built-in software of CCDOPS to give you a chart of RA and DEC drift while doing "track and accumulate". Within minutes you can tell if the azimuth and altitude axis are off, and in which direction you have to turn the two adjustment screws. This method is so sensitive that in 5 minutes, Roland can see the difference that a mere 1/16 turn on the azimuth axis has made in his dec drift.

Using CCDOPS, go to Track& Accumulate. Choose a star to track on and start a series of 5 exposures of 30 seconds each, 2x2 binned. The T&A function in CCDOPS has a neat little chart that shows you how far the star has drifted after each 30-second exposure. The following describes one of Roland's sessions: "After two exposures, we could already see that the dec was tracking pretty good, but the RA was drifting up on the chart. First we lowered the polar axis about 1/8 turn on the big altitude knob, but the star drift was now twice as large. Back to the start position, and 1/16 turn at a time, we went from 3-pixel drift to an average of 0.8 pixels RA, and 0.2 pixels Dec per 30-second exposure. The 0.8 pixels drifted up and down along the axis, which meant that the main component now was periodic error (approx +- 2.2 arc sec. with the 38.8" FL)."

4. Final precision adjustment of the polar axis.
  - a) Use CCDOPS - To get the scope to track accurately for many minutes means you have to remove the periodic error, and make your final altitude and azimuth adjustments so that the average drift is as low as possible on the T&A chart. Go into the self-guide mode and choose a 1second guide time, then program the PEM in the servo drive. The program takes about 7 minutes is perfect to get a really accurate periodic error function.
  - b) Use PEMPro - PEMPro is a Microsoft Windows by Ray Gralak and distributed by CCDware. This powerful application will analyze and improve the performance of any mount that is equipped with a CCD camera and compatible camera control software. PEMPro will reveal your mount's performance in real time regardless of seeing conditions and dramatically improves guided and unguided imaging resulting in better images and fewer lost exposures. This software is also available from Astro-Physics. A special PEMProAP edition will be included with 1200GTO and 900GTO mounts shipped beginning December 2004.

## ***Using Software to Improve Pointing Accuracy***

Software solutions are available today that will help to compensate for orthogonal problems as well as other idiosyncrasies of your telescope, mount and optics. These programs analyze and compensate for these problems, resulting in improved telescope pointing performance.

- TPoint Telescope Pointing Analysis Software from Software Bisque, [www.bisque.com](http://www.bisque.com)
- Telescope Mount Modelling Software from Diffraction Limited, [www.cyanogen.com](http://www.cyanogen.com)

## ***How to Find Objects if You Have Less Than Perfect Polar Alignment or Non-Orthogonal Systems***

Yes, it is possible to find objects with the mounting not perfectly polar aligned. One simple and effective way is to use the Tour Mode to find and center a bright star in the constellation or area of the sky where you wish to find a faint object. Choose a bright star (use  $\alpha$ ,  $\beta$  or any of the first few stars in the constellation list) in the area of the sky that you wish to explore, press GOTO and center the star in your finder and/or telescope field with the N-S-E-W buttons. Press the RA/DEC/REV button on your keypad, Then, select 9=Re-calibrate. Now, you can tour around the neighborhood of that constellation, and, unless your polar alignment is way off, you should be able to find objects in your telescope eyepiece.

While you are in a particular constellation, be sure to check out the prominent doubles. You can access them by pressing button 6=More then button 2=ADS Double Stars. Some constellations have up to a dozen interesting doubles, which are fun to observe.

How far off is off? If your polar alignment is off by 1 degree, and you calibrate on a star near the celestial equator on the meridian, your error will be about + - 1 degree going from the eastern to the western horizon. If you start in an area 1 hour from the calibration star, your error will be about + - 5 arc minutes. An 8" f10 scope with a 12mm Plössl ocular has an 18 arc-minute field, so the object would appear within the center 1/3 of the eyepiece field of view.

## ***What if I Lose My Calibration?***

Assuming that you are polar-aligned, you can use the sync or re-calibrate functions as described under Advanced Features later in the manual..

# AUTO-CONNECT SEQUENCE - FOR PERMANENT, POLAR-ALIGNED MOUNTS

Auto-connect is a simplified startup sequence appropriate for mounts that meet the following requirements:

- Remains at a fixed location
- Polar-aligned
- Telescope position was not disturbed since it was last used.
- You are not using an external computer to control your mount.

Please remember that you must follow the Normal Startup Sequence described in the previous section during your first session at this location before setting your Auto-Connect to YES.

This feature can be activated or de-activated in the Keypad Options Menu. You can access this by pressing Setup, then pressing #3=Keypad Options. Press button #1 to toggle between “YES”, “NO” and “EXT”.

When the keypad is in the Auto-connect mode, all you need to do is connect power and the system will remember where you left off. The Main Menu will appear on the screen so that you can go directly to the Objects Menu and enter the desired objects to be viewed.

If the scope has been moved (but the mount has remained stationary), you will have to find a reference star, planet or other object in the eyepiece and sync the scope on that object with the following procedure:

1. **The Main Menu will display when you power up.**
2. **Point your telescope to a known star or solar system object.** Center in the eyepiece. (If the object drifts, you will know that you are not truly polar-aligned).
3. **Go to Objects → Strs.** Note, this list also includes solar system objects at the end of the list that you can use. The <PREV button will take you to the end of the list.
4. **Select your target object.** The Cal Star Menu will appear for that object. Note the “>” sign in the upper right corner.
5. **Press >NEXT and the Sync menu will appear.** Double check to be sure the object is still centered.
6. **Press 1=Sync current object and Menu to exit.**
7. **Note:** Alternatively, you may sync through the Stars/Constellation routine. It is also possible to sync on Messier, NGC, IC, Abell galaxies, ADS double stars and Objects/Constellation; however since these objects are not discrete points (or have two points, as in double stars), they are not the ideal choice for syncing.

If the scope is only off a small amount after slewing to an object, you can move the object into the center of the field with your N-S-E-W buttons or by physically pushing the tube assembly and then hit the Recal button #9 in the Objects Menu (see Recalibration section).

## Important Points

### Meridian Delay

- If you had used the Meridian Delay feature in the last observing session, then removed the power at the end of the session – When you apply power again, the meridian delay information is used to



*10" f14.6 Maksutov-Cassegrain on 1200GTO  
in observatory*

determine the position of the mount, then resets to zero. This forces you to set up the meridian delay for each session to prevent unintended consequences.

- If you parked the mount, but did not remove power – When you unpark the meridian delay setting will still be active. Be very careful to remember your settings.

# EXTERNAL STARTUP SEQUENCE – FOR MOUNTS THAT ARE CONTROLLED BY AN EXTERNAL COMPUTER.

Auto-Connect: EXT is a simplified startup sequence appropriate for mounts that meet both of these requirements:

- Precisely polar-aligned
- Your mount is connected to a computer with telescope control software

This feature can be activated or de-activated in the Auto-Connect settings in the Keypad Options Menu. You can access this menu by pressing Setup, then pressing #3 to enter into the Keypad Options Menu. Press #1 to toggle between: YES, NO, and EXT.

Once Auto-Connect is set to EXT, press the Menu button until you get to the Main Menu, and then power the mount down in order to activate this feature.

1. **Prepare your computer and software.** Have your computer on with your telescope control software running and connected to the mount via either COM port on the control box.
2. **Power up your Mount and the External Startup Screen will appear on the keypad.** This screen will check the mount every few seconds to see if the computer has sent it the location and time data it needs to complete the startup process.
3. **Connect to your mount in the computer software.** The display on the keypad should now change to the Main Menu. If it does not, slew to an object close to where the telescope is pointing. Some software only sends the time and location data to the mount after a slew, not at connection.
4. **The Mount should now show the Main Menu and you are ready to use the keypad.** If your telescope was moved since last time you used it, you may need to re-calibrate on a star. Refer to “Auto-Start Sequence – For Permanent, Polar-Aligned Mounts” in your GTO Keypad manual for this procedure.

Keypad Options Menu

<b>1=Auto-Connect:NO</b>
<b>2/3=Reticle :0</b>
<b>4=Focus :High</b>

External Start Screen

<b>External Startup</b>
<b>Press Menu to Cancel</b>
<b>external startup.</b>

## Important Point

If you have used the External Startup Sequence, do not attempt to change the time on your keypad. Use the computer program to control the time.

# OBJECTS MENU - HAVE SOME FUN!

Objects Menu

<=Object RA/DEC=>		
1=M	4=Sol	7=R/D
2=NGC	5=Strs	8=Tour
3=IC	6=More	9=Rcal

## Tips for Using the Buttons and Menus

- **Correcting data entries** - When entering catalog numbers into the keypad, you can use <PREV button to delete last digit entered. Enter correct digit.
- **Scrolling object lists** - Some of the object selection screens will display "<" and/or ">", usually in the corners. These symbols indicate that you can scroll a list of objects using the <PREV or NEXT> buttons. If you hold these buttons, the object names will scroll quickly in some screens (e.g. stars).
- **N-S-E-W directional buttons** - The N-S-E-W directional buttons can be used when you are in the Main Menu, Object Menu, Photographic Timer, most Setup Menus, and when the object data screens are displayed. They are not active when you are in object selection screens, i.e. when entering a Messier number.
- **Review object data of catalog items prior to slew** – Enter the number of the object that you are considering, then press >NEXT. The magnitude, object type (galaxy, globular cluster, etc.) and constellation will display. You can press GOTO in this screen to initiate a slew, if you wish, or press MENU to exit to make an alternate selection.
- **Display current object** - Return to Object Menu and press <PREV button. The object data for the last object that was selected for a slew (or that you synched on) will display.
- **Display coordinates of catalog object after a slew** – Press <PREV button. The catalog RA and Dec coordinates will display. Note that the coordinates of the solar system objects display on the selection screen before you slew.
- **Actual current RA/Dec coordinates** - When you are in Objects Menu, press NEXT>. The RA/Dec coordinates of the exact position of your mount will display. These may be slightly different from the above display since the calculations that compensate for atmospheric refraction and precession will change the coordinates slightly. Also, if you move the mount with the N-S-E-W directional buttons or with a software program such as *The Sky*, this display screen will be updated.
- **Actual current Alt/Az coordinates** - When you are in Objects Menu, press NEXT>. The Alt/Az coordinates of the exact position of your mount will display. Also, if you move the mount with the N-S-E-W directional buttons or with a software program such as *The Sky*, this display screen will be updated and the display by current object screen will not.
- **Re-calibration** - You can re-calibrate on current object at any time to fine-tune your calibration. Simply press the RA/DEC REV button on the keypad, center the object in your eyepiece with the N-S-E-W directional buttons and select 9=Re-calibrate. Please read section of the manual that discusses the uses of the re-calibrate and sync functions.
- **Sync** – You can sync on a current object after a slew by pressing the >NEXT button and selecting 1. Please read section of the manual that discusses the uses of the re-calibrate and sync functions.
- **Cancel slewing at any time** - Press STOP to cancel a slewing operation. Your telescope will stop immediately. The mount will know where it is, so proceed to the next object using the N-S-E-W buttons or catalog requests described below. Do not move the telescope by hand or you will lose calibration.

## Procedures Common to all Slewing Commands

- Begin all slewing requests at the Objects Menu (Main Menu → Objects).
- When you press GOTO, if the object is visible from your location and within your safe-zone setting, the mount will slew automatically. If not, the screen will display the message "Object below horizon" or "Outside Safe Zone Slewing canceled ...".
- When you are ready to choose the next object to observe, press MENU once or twice as needed to return to a selection menu.
- Although the procedures for each catalog are outlined below, you will find that it is very easy to navigate. The commands are either intuitive or the screen provides instruction. You will quickly move from one object to another.

- If you move the telescope manually at any time, other than the initial calibration routine, you will lose calibration. See section “What if I lose my calibration?”
- A word about catalog databases. The RA and Dec coordinates for the objects in these catalogs are based on the year 2000. Nevertheless, you will undoubtedly find differences when comparing the data to other sources even if they are also based on the year 2000. Slight differences are acceptable. We have added precession and atmospheric refraction calculations, so the actual RA and Dec coordinate position to which you will slew will vary slightly from the catalog numbers. Please let us know if you find gross discrepancies.

The separation data of double stars in the ADS catalog is based on “average” numbers. As you know the apparent separation can vary from year to year. Please consult an ephemeris for the most accurate data.

Magnitudes are estimates and may vary from one source to another. Also, some stars are variable. Some values are missing from the database and will display zeros in the field.

## M, NGC, IC

These are the most common catalogs used in astronomy and include the brightest and most famous objects including galaxies, diffuse (bright) nebulae, planetary nebulae, globular clusters and open clusters. Many faint objects visible only in larger instruments are included also. A few objects are listed in more than one catalog, so there is some overlap. M (Messier) = 110 objects, NGC (New General Catalog) = 7,840 objects, IC (Index Catalog) = 5,386 objects.

1. **Go to Objects Menu.**
2. **Choose M, NGC or IC** - press the number that corresponds to your choice (e.g. M=1).
3. **Enter the catalog number with your keypad.**
4. **Choose action:**
  - a) **Press GOTO to initiate slewing.**
  - b) **Press >NEXT to view the object data, then press GOTO to slew.**
  - c) **Press >NEXT again to go to the Sync Menu, if you wish (assuming that you are already pointing at that object).**
  - d) **Press MENU to return to Objects Menu.**

## Common Object Names

This is one of our favorite features. Many of us can't remember the catalog number of an object, however we remember the common name. Use this procedure to view 100 of your favorites.

1. **From Objects Menu, select Tour.**
2. **Select Common Obj. Names.** Use <PREV and NEXT> to scroll through list of names.
3. **Choose object.** The screen will display the magnitude, type of object and the constellation where it is found.
4. **Press GOTO to initiate slewing, >NEXT to go to the Sync Menu or <PREV to display RA and DEC coordinates.**

Common Object Names Menu

<b>Common Names:</b>	
1=47 Tuc	<
2=Andromeda Galaxy	
3=Antennae	>

## Solar System Objects (Sol)

All the planets, the Moon and the Sun.

**WARNING** - Observing during the daytime can be dangerous. You must refer to the section entitled “Slewing During the Day” for precautions.

1. **From Objects Menu, select Sol (Solar).**

2. **Press the number that corresponds to your choice.** The coordinates of the object will display. If not, the display will indicate that it is below the horizon.
3. **Press GOTO to initiate slewing or Menu = Exit.** If you select GOTO, the mount will slew to the object. The magnitude and constellation data will not display for these objects. If the object is below the horizon, the display will provide that information.

Solar System Menu

<b>Solar Menu</b>	<b>7=Satn</b>
<b>1=Sun</b>	<b>4=Ven 8=Uran</b>
<b>2=Moon</b>	<b>5=Mars 9=Nept</b>
<b>3=Merc</b>	<b>6=Jupt 0=Plu</b>

## Common Star Names - Non-scientific

Many of these names are of Arabic origin. Refer to "Appendix D: Alphabetical Star List" for the stars that we have included. The appendix also shows the Flamsteed-Bayer names and the approximate magnitude of each star.

1. **From Objects Menu, choose Strs (Stars).**
2. **Select the star you wish to observe.** Scroll the stars list by pressing the <PREV or NEXT> buttons. Hold button down for a more rapid scroll rate. Press the number that corresponds to your choice. The RA and DEC coordinates will display.
3. **Press GOTO to initiate slewing, >NEXT to Sync, <PREV to select another star or MENU to return to the Object Menu.**

Star Selection Menu

<b>Choose Star</b>	<b>Z=05:54</b>
<b>1=Polaris</b>	<b>&lt;</b>
<b>2=Acamar</b>	
<b>3=Achernar</b>	<b>&gt;</b>

## Greek Star Names, organized by constellation

This menu showcases the brightest stars in each constellation.

1. **From Objects Menu, select Tour.**
2. **Select Stars/Constell.** The display will identify the constellation to which your telescope is pointing and offer choices of stars with Greek names within that constellation. Refer to "Appendix E: Constellation Abbreviations" for the full names of the constellation and "Appendix H: The Greek Alphabet" to help read your star charts.
  - a) Use <PREV and NEXT> buttons to scroll through constellation lists. Choose a constellation that is visible.
  - b) Press 6 or 0 to scroll through the list of stars available within the current constellation.
3. **Choose a star.** Screen will display the magnitude of the star.
4. **You have several choices:** Press GOTO to initiate slewing, >NEXT to sync, <PREV for RA and DEC coordinates or MENU to exit to the Stars/Constellation Menu.

Stars/Constell. Menu

<b>&lt; - Cons: And + &gt;</b>
<b>1=alf 3=chi</b>
<b>2=bet 4=del</b>
<b>6=Prev Stars Next=0</b>

Constellation Star Screen

<b>And alf</b>	<b>&lt;</b>
<b>Mag : 02.6</b>	<b>Con:And</b>
<b>Type: Stars</b>	
<b>Menu=Exit</b>	<b>&gt;</b>

## Abell Galaxy Clusters

We have included 2,712 of the Abell Galaxy Clusters.

1. **From Objects Menu, choose "More".** This will bring you to the More Objects Menu.
2. **Choose Abell Galaxies.**
3. **Enter Abell Number.** Note that not all Abell Galaxies are in the database
4. **Choose action:**
  - e) **Press GOTO to initiate slewing.** If the number that you have entered is not in the database or is below the horizon, the display will let you know.
  - f) **Press >NEXT to view the object data, then press GOTO to slew or >NEXT to display the sync menu.**
5. **Press MENU to return to More Objects Menu to make an alternate choice.**

More Objects Menu

<b>1=Abell Galaxies</b>
<b>2=ADS Double Stars</b>
<b>3=Search</b>
<b>4=What's Up Now</b>



## ADS Double Stars (Aitken Double Star Catalog)

We have included 215 of the most popular double stars in this catalog. Please refer to Appendix G: Aitken's Double Star (ADS) list for the ADS numbers that we have included and the corresponding Greek star name.

1. **From Objects Menu, choose "More"**. This will bring you to the More Objects Menu.
2. **Choose ADS Double Stars**. The screen will display the name of the constellation to which your telescope is pointed. A list of ADS objects within that constellation is shown.
  - a) Use <PREV and NEXT> buttons to scroll through constellation lists. Choose a constellation that is visible.
  - b) Press 6 or 0 to scroll through the list of stars available within the current constellation.
3. **Choose a double star**. When you select an object, the screen will display the approximate separation of the stars, constellation and object type. Remember that apparent separation may vary from year to year. Consult an ephemeris for the most accurate data.
4. **Press GOTO to initiate slewing, >NEXT to sync, <PREV to view RA and Dec coordinates or MENU to exit.**

ADS Double Stars Menu

< -	<b>Cons: And</b>	+ >
1=00513	3=01630	
2=00755	4=01683	
6=Prev	ADS	Next=0

## Search for Objects by Type, Magnitude, Catalog and All Sky vs. Current Constellation

Use this routine to specify search parameters, e.g. if you want to view all the open clusters in the Messier catalog up to 9th magnitude that are visible in the entire sky. This is particularly useful to tailor the list to your aperture or observing preferences, or just for fun.

1. **From Objects Menu, select "More"**. This will bring you to the More Objects Menu.
2. **Select Search Function**. The screen shown will appear.
3. **Use the keypad to make selections to narrow the range of your search.**
  - a) **Range** - Press 1 to alternate between these choices: All Sky and Cur. Con. (current constellation).
  - b) **Type** - Press 2 to alternate between these choices: All, Galaxy, Open Clus (open cluster), Glob Clus (globular cluster), Planetary (planetary nebula), Nebula, Dbl. Star (double star)
  - c) **Mag** (magnitude) - Press 3 to scroll between magnitude levels of 1-20. This will identify the highest magnitude that will be included. Use this to limit your search range to objects that are easily viewed in your telescope.
 

The search looks at the whole number of the magnitude so if you specify a limit of 10 in your search, objects between 10-11 will appear also (e.g. 10.6).

If an object does not have magnitude data available, it is stored as "0". As a result, these objects will appear in your search even if they actually exceed your limit.
  - d) **DB** (database or catalog) - Press 4 to alternate between these choices: Mess (Messier), NGC and IC
  - e) **Press GOTO**. The screen will display "Searching".
    - i) The display will show the first item of the search and give you several choices as shown.
    - ii) If there are no objects that meet this criterion, the Search Menu screen will reappear. Specify new search criterion.

Search Screen

1=Range: All Sky
2=Type : All
3=Mag:10 4=DB: Mess
GoTo=Srch Menu=Exit

- iii) The search times may be 30 seconds or longer if you are searching a large database, like NGC objects.
- f) **Press GOTO again if you want to slew to this object.** The mount will slew and object data will display. Press NEXT> for the sync menu or <PREV to show RA and Dec coordinates.
- g) **Press Menu.** The next search object will display or if there aren't any more, the search menu selection screen will reappear.
- h) Press MENU again to return to Objects Menu.

## What's Up Now Function

1. **Go to the What's Up Now screen.**  
(Main Menu → Objects Menu → 6=More → 4=What's Up Now )
2. **Press the Next>.** The keypad will search its M, NGC, and IC databases and randomly suggest an object that is above the horizon at your location. Due to the complex calculations that are made to select an object, you may notice a slight pause with a message **\*\*what's up\*\*** after pressing the NEXT> button. This is normal. The selection is random but based on what is above your current sky horizon and if there is any horizon limit set in the keypad. See "Set Horizon Limits For Your Telescope" for more information about this feature.
3. A typical response from What's Up shows the catalog #, magnitude, object type and constellation. You may then press GOTO to slew to that object or NEXT> to find a new one.

More Objects Menu

<b>1=Abell Galaxies</b> <b>2=ADS Double Stars</b> <b>3=Search</b> <b>4=What's Up Now</b>
---

What's Up Now Screen

<b>What's Up Now</b> <b>Press '&gt;' requests</b> <b>what's Up object...</b> <b>Press Menu to Exit</b>
---

## Tour Objects within Constellations

If you are observing within a constellation and want to know what other Messier, NGC or IC objects are nearby, this tour will provide you with lots of observing ideas.

1. **From Objects Menu, select Tour.**
2. **Select Objects/Constell.** The display will identify the constellation to which your telescope is pointing and offer choices of objects within that constellation.
3. Use <PREV and NEXT> buttons to scroll through the alphabetical constellation lists. Choose a constellation that is visible.
4. Press 6 or 0 to scroll through the list of objects available within the current constellation.
5. **Choose an object.** Screen will display object data including magnitude, object type and the constellation.
6. Press GOTO to initiate slewing, NEXT> to sync or <PREV to display RA and Dec coordinates.

## Custom RA and DEC Coordinates

This menu option allows you to slew to any position in the sky as long as you know the RA and Dec coordinates. This feature is particularly handy if you wish to locate comets, super novas, asteroids or any object that is not included in our catalogs.

1. **From Objects Menu, select R/D.** The Custom RA/DEC Entry will appear.
2. **Enter RA and Dec coordinates.** Press >NEXT to bypass any numbers that you do not wish to change. Press <PREV if you want to back up to correct an error. To change the "+" or "-" press the "+ -" button.
3. **Press GOTO to initiate slew or Menu=Exit.**

Custom RA/DEC Entry Screen

<b>Custom RA/DEC Entry</b> <b>RA : 19:30:43</b> <b>DEC: +27:57:34</b> <b>GOTO / Menu to Exit</b>
---

When the slew is complete, press MENU to return to the Objects Menu. If you press >NEXT, the RA and Dec coordinates will appear. Note: in earlier version of the keypad firmware, the RA/Dec coordinates were used for an RA Position Memory feature. However, this feature limited the normal function and was confusing to most users.

## Custom ALT / AZ Coordinates

This menu option allows you to slew to any position in the sky as long as you know the altitude and azimuth angles. This feature is particularly handy if you wish to take your dark frame for CCD imaging or observe terrestrial objects with the tracking turned off.

1. **From Objects Menu, select AIAz.** The Custom Alt/Az Entry will appear.
2. **Enter Altitude and Azimuth coordinates.**
3. **Press GOTO to initiate slew or MENU to Exit.** Use <PREV to make corrections. You will now return to the Objects Menu.

Custom Alt/Az Entry Screen

<b>Custom ALT/Az Entry</b>
<b>Alt : 00:00:00</b>
<b>Az : 000:00:00</b>
<b>GOTO / Menu to Exit</b>

## Sun Warning

It is important to remember that slewing to objects near the sun can be quite dangerous to your eyesight. If the sun is above the horizon, the keypad will go through an additional check routine to be sure that the object or position that you select is outside a safe viewing zone. If the object is the sun itself or within 15 degrees of the sun, the following warning will display:

Sun Warning Screen

<b>WARNING: Looking at or near the SUN can DAMAGE your eyes. GOTO / Menu=Exit</b>
---

Please be sure that you have installed a good quality SAFE filter that covers the optics in front of the telescope. Never use eyepiece filters since they may break due to the intense heat of the sun. Do not use solar filters that are cracked (glass), torn (mylar) or have many pinholes (either glass and mylar).

# MAIN MENU FUNCTIONS

## ***Brightness of the display screen***

Use the <PREV and NEXT> buttons to adjust the brightness of the display to a bright or dim setting.

Note: Even when the keypad is set to the bright setting, it will be difficult to see during daylight hours. You will need to shield it with your hands. This is an unfortunate drawback of the vacuum-fluorescent screen. We originally chose this display because of its excellent performance in cold weather down to -40° F (-40°C, yes, the number is the same). Alternative displays scroll very slowly at temperatures below freezing and would not work well at all in extreme temperatures. Since many of our customers (and ourselves) observe during the cold Midwestern winter months, we opted for performance.

1=Object	5=S:1200
2=Setup	6=B:600
3=Tools	7=A:1
4=Time/LST	8=T:Side

## ***Directional buttons***

The N-S-E-W buttons are active at this point.

## ***Objects***

This is your gateway to all object databases, tour functions and the RA/Dec coordinate entry screen. Refer to the previous section of the manual for a complete discussion of the options available here.

## ***Setup***

Refer to the next section of the manual for a complete discussion of the options available here.

## ***Tools***

Refer to a later section of the manual for a complete discussion of the options available here.

## ***Time/LST***

This display screen will show your local time, date, LST (local sidereal time, also known as the zenith hour) and GMT (Greenwich Mean Time, also known as UST – Universal Standard Time). If you have not gone through the startup routine, only the local time and date will display. It cannot calculate LST and GMT until you enter your location (unless Auto-start is set to “yes”). Press and hold MENU button a few seconds to exit screen. In addition, the current selected location will appear in the lower right corner. For example, LOC=1 indicates that location 1 is currently selected.

TIME: 17:40:12
DATE:07:06:1998
GMT: 22:40:29
LST: 11:42 LOC:1

You will notice that the display will appear to skip a second once in a while. This happens because the display does not update exactly in sync with the clock. As a result, it gets slightly behind and has to skip a second to catch up. This is not a problem.

This is a display screen only. You must go into the Location and Time menu to change the data, time and location.

## ***Slew rate (S:)***

Press “5” on your keypad to change slew rate: 1200x, 900x, or 600x. Note that the selection changes (toggles) each time you press the button. We recommend that you use slower rates in cold weather.

## ***Button rate (B:)***

Press “6” on your keypad to change the button rate: .25x, .5x, 1x, 12x, 64x, 600x, or 1200x. This determines the rate that the mount will move when the N-S-E-W directional buttons are pushed. The selection changes each time you press the button. This rate can also be changed on a display screen accessed by the + - button.

## ***Guiding rate(A:)***

Press "7" on your keypad to change the Guiding rate: .25x, .5x, or 1x. This determines the rate that the mount will move when an auto-guider or computer guiding program moves the mount through the auto guider port on the control box. The selection changes each time you press the button.

Note: The GTO servo control box on your mount uses the last guide rate command sent to it. The guide rate can either be controlled by the keypad or an external source. If an external source sends the last command, the display of the keypad cannot display the new rate.

## ***Tracking rate (T:)***

Press "8" on your keypad to change the tracking rate: Side (Sidereal), Sol (Solar), Lun (Lunar) and Stop

## ***Casual observing***

If you just want to make quick casual visual observations with your telescope and do not plan to use the go-to features of the keypad controller, you can operate your telescope totally from this screen. Since you have set up your mount with the polar axis pointing toward Polaris (or the southern celestial pole) the RA tracking rate will help to keep your object in the field of view. You will, of course, have to move your telescope by hand from one object to another or use the directional buttons. If you have encoders installed (optional accessory), you can use JMI Digital Setting Circles (optional accessory).

# SETUP MENUS

## *Locations & Time Menu*

### **Set Site Location**

Refer to the earlier “Getting Started – Do This at Home” section for this information.

### **Set Date & Time**

Refer to the earlier “Getting Started – Do This at Home” section for this information.

### **Get Time/Loc FrMnt**

If you are using an external computer to control your telescope, the mount and the keypad could be using different location and time settings. This command will sync the keypad with the last location that was sent to the mount by the computer through the RS-232 serial port. This feature is extremely handy for computers synced with atomic clocks and GPS units.

When this feature is selected, a display will appear with the information the keypad has obtained from the mount. Compare this screen to your computer’s settings to be sure they match. If they do not match closely you may need to send the computer settings to the mount again by using the initialize command in The Sky or by sending a slew command in other telescope control programs.

Press menu to leave this prompt. You will also notice if you have used this feature that your location indicator in the Time/LST menu will show LOC: E. This indicates that you are using the external information in the mount to establish your location and time rather than your preset locations in the keypads memory.

**Note:** You cannot manually edit the time with your keypad if you have selected the Get Time/Loc Fr Mnt. If you need to update your time, please enter the Get Time/Loc Fr Mnt command again.

Setup Menu

1=Locations & Time 2=Mount Move Limits 3=Keypad Options 4=Park / Mount Opt.
--

Get Time/Loc FrMnt Screen

TIME:21:12:38 LONG:W 089:25:00 LAT :N 42:38:00
--

## Mount Move Limits Menu

Mount Movement Menu

1=RA Backlash	: 0
2=DEC Backlash	: 0
3=Safe Zone	: 00
4=Horizon Lim.	: 00

### R.A. Backlash Adjustment

Since the R.A. motor is always running, there is no backlash or delay in the R.A. motion in 0.25x, 0.5x, and 1x. Where R.A. backlash becomes noticeable is in the 12x, 64x and higher slew rates. Here, backlash will manifest itself as a delay in the continuation of the R.A. drive. In other words, the star will continue to drift for a number of seconds after letting go of one of the two directional buttons (E or W). This is the time it takes for the motor gear train to completely reverse again in order to begin the normal tracking. For that reason, we added a short pulse of 64x sidereal to get the gearbox to re-engage quickly. There is no drift in the other direction because you are not unwinding the gear train. Adjustment of the backlash is very simple.

1. **At Main Menu, press 6=B.** This controls the speed of your N-S-E-W directional buttons. Continue to press 6 to scroll (toggle) through choices. You can also access your button speed anywhere you can use them by pressing the + - button and using the Button rate menu.
2. **Select 12x or any higher speed.** We recommend 12x since this is the easiest to evaluate.
3. **Choose Setup from the Main Menu.**
4. **Choose Mount Move Limits from the setup menu.**
5. **Press 1=RA Backlash.** As you continue to press 1, the number field will scroll 0-9. Zero will have no compensation and 9 will probably be overcompensated.
6. **Stop selection on 3 (or any other number you choose).** We recommend that you start with 3 if you are beginning your adjustment.
7. **While viewing a star at high power through an eyepiece, use the E-W buttons to test this setting at 12x.** With the proper backlash setting, the star will appear to stop moving right when the button is released. Too high a setting will cause the star to jump back a bit. If this happens select the previous number. You can now test this with out leaving the Mount Move Limits menu.
8. **Repeat process, increasing or decreasing the RA Backlash setting by 1 each time to evaluate changes.**
9. **The number will remain in permanent memory and will not need to be set again.**

The RA and Dec backlash settings are retained in the keypad memory. Each time you initialize the mount with the keypad, these values are sent to the ROM chip in the GTO control box. The amount of backlash can vary depending on load and orientation of the telescope. It can never be precisely set, so there will always be a small delay or small overshoot.

### Declination Backlash Adjustment

When using the 1x, .5x and .25x guide rates in declination, you may find that there is a delay when attempting to reverse the motion of the star. Normally declination drift is only in one direction and will require correction with only one button. However, occasionally it may be necessary to reverse the motion. The multiple gear trains inside the drive motors take a number of encoder pulses to unwind and rewind in the opposite direction. To compensate for this, we have included a circuit that pulses the motor very rapidly for a moment before continuing at the slower rate. Because the delay varies with each motor, we have programmed a 10-position adjustment, which can be used to dial in the exact amount of compensation.

1. **At Main Menu, press 6=B.** This controls the speed of your N-S-E-W directional buttons. Continue to press 6 to scroll (toggle) through choices. You can also access your button speed anywhere you can use them by pressing the +/- button and using the Button rate menu.
2. **Select .25x.**
3. **Choose Setup from the Main Menu.**
4. **Choose Mount Move Limits from the setup menu.**

5. **Press 2=DEC Backlash.** As you continue to press 2, the number field will scroll 0-9.
6. **Stop selection on 3 (or any other number you choose).** We recommend that you start with 3 if you are beginning your adjustment.
7. **While viewing a star at high power through an eyepiece, use the N-S buttons to test this setting at .25x.** You have set the compensation number correctly when the telescope will move almost instantaneously when reversing the direction in declination. You can now test this with out leaving the Mount Move Limits menu.
8. **Repeat process, increasing Dec Backlash setting by 1 each time to evaluate changes.**
9. **The number will remain in permanent memory and will not need to be set again.**

Normally, Dec backlash is adjusted only for manual guided astrophotography where the scope is always in one orientation for a long time. Even here, a different adjustment may be needed in different parts of the sky.



## Set Safe Zone Limits for Your Telescope

Astro-Physics mounts are used with a wide variety of telescopes, piers, tripods and accessories. You may determine that if the telescope attempts to point to some areas of the sky, it may hit the pier or tripod. The safe zone function will allow you to control the area in which the scope is allowed to slew. Based on your safe zone setting, the keypad will determine whether the object that you have selected for slewing is within a restricted zone or the safe zone. If the object is in an area of the sky within the restricted zone, your keypad will display "Outside Safe Zone, Slewing canceled..." However, if you are slewing with the N-S-E-W buttons, there are no restrictions, so you must watch carefully.

### How to Determine Your Safe Zone

Set up your telescope with all of the accessories you plan to use and balance your load. Move your scope through its range of motion. Can you point the scope straight up without hitting the pier or tripod? If so, leave your safe zone set at 0 degrees. This means that the entire sky can be accessed. The telescope in the photograph does not require a safe zone setting. It will move safely into all positions with the 6x7 camera.

If your telescope is in danger of hitting the tripod, you must set your safe zone to some number between 0-20 degrees.

To determine this setting, move your counterweight bar to a position parallel with the ground. Take care that the telescope and accessories are moved out of the way of the pier or tripod. Note the position setting of the RA circle when the counterweight shaft is in this parallel position. Now, gradually move your telescope by hand to the limit of the safe zone you wish to set – as close to the pier/tripod that you are comfortable. Note the change in the position of the RA setting circle. You can calculate the safe zone setting based on this difference, knowing that each hour is equal to 15 degrees. For each of these mounts, each tic mark on the RA setting circle is equivalent to these values:

- 1200GTO – 1 degrees
- 900GTO – 1.25 degrees
- 600EGTO - 2.5 degrees
- 400GTO – 2.5 degrees

The safe zone setting may vary depending on what accessories are on your scope, e.g. CCD camera with filter wheel, Daystar H-alpha filter or just an eyepiece.

Remember that if you set your safe zone to a number greater than 0, you will also lose a corresponding amount of the zenith as shown in the photo.

The software that controls the mount sets the safe zone. In this manual, we are discussing keypad control. However, if you are using an external software program, that program controls the safe zone. The keypad settings are not active in that situation. For instance, you can set your "safe zone" in DigitalSky Voice and the "Telescope Limit Line" in TheSky. The programs themselves do the calculations for the target object (is it within the safe zone or out-of-bounds?) to determine whether the mount should slew or not. If it is safe, the RA/Dec numbers are sent to the mount. If not, you are informed that the object is outside the limits. If the software program does not contain some sort of safeguard to assure the safe position of your telescope, you must be very careful and watch the movements during a slew. The mount will slew wherever it is told, even if it is not safe.

### Set Your Safe Zone

1. **Go to Mount Move Limits Menu.** (Main Menu → Setup Menu → Mount Move Limits Menu).
2. **Press 3=Safe Zone.** Notice that the number field changes.
3. **Enter number of degrees.** As you continue to hold #3, the number choices increase from 0-20 and back to zero. Release #3 to stop the scroll through the numbers.



# Set Horizon Limits for Your Telescope

Astro-Physics mounts are used in wide variety of locations. You may determine that if the telescope attempts to point to some areas of the sky, that the object will end up behind a wall, a hill or some other obstruction that limits your horizon.

The horizon limit function will allow you to control the area in which the scope is allowed to slew. Based on your horizon limit setting, the keypad will determine whether the object that you have selected for slewing is above the horizon or not. If the object is in an area of the sky that is below the Horizon Limit that was set, your keypad will display "Object Below Horizon Limit. Altitude: [Value]" The value indicates how many degrees the object is above the actual horizon if you were viewing from a perfectly flat location. If the number is within a degree or two of the limit you have set or you know you have a lower horizon in the direction the object is in, you can hit GOTO and mount will slew to the object. Alternately you may hit menu to cancel the slew and choose another object from the objects menu.

### How to Determine Your Horizon Limit

Set up your telescope at the observing location. Take note of any area around the horizon that may be obstructed, i.e. by trees, houses, observatory walls, mountains, hills and so on. If you are in a valley or an observatory with high walls, your horizon limit setting will be higher than an observer on a hilltop or on an island looking over a large body of water.

Move your scope through its range of motion, notice where you cannot see the sky through the telescope. If you can see the sky in every direction you slew the scope then leave your horizon limit set at 0 degrees. This means that the entire sky can be accessed and observed without obstruction. If you do end up with obstructions you can consider setting the horizon limit.

### How Horizon Limit Works

Observer A's site is on a hill with a very long distant local horizon, whereas Observer B is in a valley with a very close and obstructed horizon. Observer A would set their horizon limit at 0 because they can see the entire sky. Whereas Observer B in the valley would set their horizon limit to around 20 to tell the mount to prompt them if they attempt to slew to an object that would be below their local horizon.

If Observer B attempted to view Star 1 the object would be below their horizon (hidden by a nearby hill) and the keypad would prompt to tell them this. If Observer B attempted to view Star 2 the keypad would prompt them that the object was below the horizon but Observer B would know they could see Star 2 and would press GOTO to override the horizon limit slew to mount to observe it.

Remember that if you set your horizon limit to a number greater than 0, you will be prompted to view any object below the limit. If you are prompted often for objects that are visible above the horizon, adjust your limit lower. If you are not being prompted for objects that are below the horizon at your location, consider raising the number.

The software that controls the mount sets the horizon limit. In this manual, we are discussing keypad control. However, if you are using an external software program, that program controls the horizon. The keypad settings are not active in that situation and you might end up slewing to an object below your local horizon.

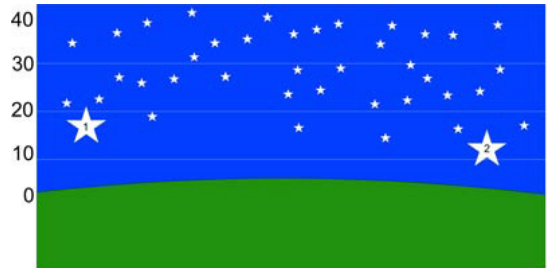
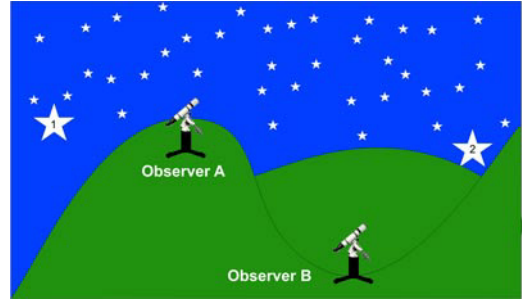

Observer A View Horizon Limit Setting = 0

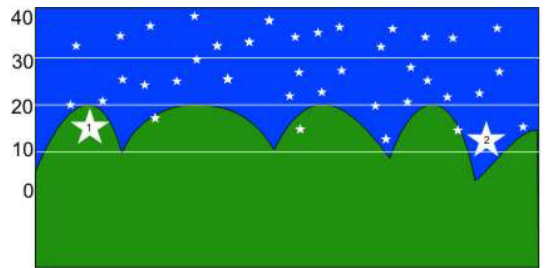

Observer B View Horizon Limit Setting = 20

### Set Your Horizon Limit

1. **Go to Mount Move Limits Menu.** (Main Menu → 2=Setup → 2=Mount Move Limits Menu).
2. **Press 4=Horizon Lim.:** Notice that the number field changes.
3. **Enter number of degrees.** As you continue to hold #4, the number choices increase from 0-50 and back to zero. Release #4 to stop the scroll through the numbers.

## Keypad Options Menu

Keypad Options Menu

<b>1=Auto-Connect:NO</b>
<b>2/3=Reticle :0</b>
<b>4=Focus :High</b>
<b>5=Keypad Update</b>

### Auto-Connect

These are the options that control how your keypad will connect to your mount when you start up at the beginning of each session. Toggle these options by pressing 1.

- If Auto-Connect is set to "NO", the Location Selection screen will appear when you start up your mount.. Refer to the section entitled: "Normal Startup Sequence – For Mounts that are Set Up in the Field." in this manual.
- If Auto-Connect is set to "YES", the Main Menu will appear. Refer to the section entitled: Auto-Connect Sequence – For Permanent, Polar-aligned Mounts"
- If Auto-Connect is set to "EXT", the keypad will wait until location and time data is sent to the mount through the serial port. Refer to the section entitled: "External Startup Sequence – For Mounts that are Controlled by an External Computer" for instructions regarding this feature. If you are not using external software during that session, press Menu. The Location Selection screen will appear so that you can initialize the mount with the keypad. Follow the procedures in the "Normal Startup Sequence – For Mounts that are Set Up in the Field" section of the manual.

### Reticle Illuminator Adjustment

The brightness of an illuminated reticle can be adjusted with the keypad. Plug the cord of the reticle into the connector on the GTO Servo Control Box.

1. **Go to the Keypad Options Menu.** (Main Menu →#2 Setup→ #3 Keypad Options).
2. **Press the 2 and 3 buttons to desired brightness level from 0-9.** Button 3 will increase, 2 will decrease.

### Focus Adjustment

If you are using an electric focuser such as the ones offered by Technical Innovations (RoboFocus), JMI or Meade, you can control the in and out focus movement with the keypad.

1. **Plug the power cord of the focus unit into the GTO Servo Control Box.**
2. **Hold the focus (FOC) button on the keypad with one finger and press the <PREV or NEXT> buttons to change focus.**
3. **To change the speed, go to Keypad Options Menu.** (#2 Setup→ #3Keypad Options).
4. **Press 4=Focus.** The rate choice will alternate (toggle) between Low and High.
5. **Select rate**

**Note:** If you are using the keypad and *TheSky* software together, it is best to use either one or the other to control the focus and not try to use both alternately. Use the keypad if you are standing at the eyepiece, use *TheSky* if you are focusing a CCD image from your computer screen.

Both the keypad and *TheSky* default to the slow speed when you begin your session. However If you change the keypad to the fast setting, then use *TheSky*, you will notice that *TheSky* focus speed will be fast even though "slow" has been selected from the dialog box. To gain control with *TheSky*, simply select "fast", then "slow." The speed will now operate at slow. The same is true if you focus with *TheSky* first, then switch to the keypad. Use the same technique to gain control with the keypad. This occurs

because the GTO Servo Control Box stores the last focus speed information and until you actively change the speed with either device, it will remember the speed last used.

## **Keypad Update Menu**

This feature allows updates of the keypad object database when they are available in the future. It also will allow you to set your keypad back to all of the factory default values resetting all of your entered location data and settings. You will not need to go into this menu during the normal use of your mount. If you enter this screen by mistake, press the menu button to exit.

There are two parts of the keypad firmware. One controls the actual program function/features and the second controls the object databases (RA/Dec coordinates, magnitudes, constellations).

If you press 1=Reset Keypad, your personal settings (location, time, time zone, daylight savings, RA and Dec backlash) will all be set to the default zero values. This may be useful if you purchase a used mount and wish to set the parameters yourself.

# PARK / MOUNT OPTIONS

## Park Your Telescope

The keypad allows you to park the telescope at the end of your observing session. You can then turn off the power and the mount will retain this position for the next session. When the park command is cancelled, you are ready to resume without going through the calibration routine. Once the telescope is parked, it cannot be moved by hand or the calibration will be lost and you will have to repeat the startup sequence at the beginning of your next observing session.

There are four methods of parking. You may choose one of three pre-determined park positions or you may simply remove the power and the drive electronics will store the information regarding the last position in its memory.

## Consideration

12V DC powers the mount, however you can use a 110 to 12V DC power supply (5 amp minimum) whenever 110V is available. If you have a heavy load, you may consider up to 18V. We recommend that you do not leave your mount plugged into 110V current when you are not observing. It is better to remove the power plug and all connections to other electronic equipment that is plugged into a power source, i.e serial cables connected to your computer, so that if your observatory is struck by lightning or a severe power surge occurs, your drive electronics will not be damaged. We recommend that you take the same precautions with your drive electronics that you would take with any fine electronic equipment.

## Park – 3 Positions

1. **Go to Mount Menu.** (Main Menu → Setup → Park / Mount Opt menu).
2. **Choose either 1,2 or 3 with the buttons.** Depending on which number you choose, the scope will slew to one of the park positions shown in the photos. The screen will state, "Pls wait till scope reaches park point before power off. MENU to resume"
3. **Remove the power to avoid potential damage by lightning.** Disconnect the power supply from the wall for optimal protection.
4. **Turn the power on when you are ready to begin your next observing session.**
  - a) If Auto-connect is set to "YES", the mount will begin tracking in R.A. when you apply power.
  - b) If Auto-connect is set to "NO", the mount will not begin tracking in R.A. until you choose your location from the Site Menu, then select Resume from Park.
  - c) If Auto-connect is set to "EXT", the mount will not begin tracking in R.A. until it receives location and time data from an external computer.

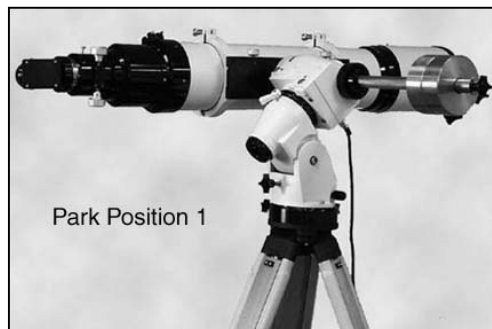

Park Position 1  
*Scope is level and pointing north. This position is also called the Reference Park Position. RA horizontal, Dec = 90 - Latitude*



Park Position 2  
*Scope is level and pointing east, RA axis vertical, Dec = 0*



Park Position 3  
*Scope is pointing to the pole. RA axis vertical, Dec = 90*

## Auto-Park – Park Wherever You Want

1. Set Auto-connect to “YES” (Main Menu → 2=Setup → 3=Keypad options menu). Toggle “1” to set “YES”, “NO” or “EXT”.
2. When you have finished your observing session, simply turn the power off. The mount will stop tracking. Please do not park the mount with the counterweights higher than the telescope. It is not a recommended park position.
3. When you restore the power, the keypad will display the Main Menu and will begin tracking in R.A. again. It will remember your location, date/time and will know where your scope is pointed (assuming that you have not moved your telescope in the interim).

## Parking and Power Considerations

The Park function in the keypad will stop the RA tracking – the mount goes into a non-driven quiescent mode. All power is removed from the servomotors, but the micro controller does not sleep and is waiting for a command to start moving again. Normally, this would be a software signal from the keypad or planetarium program, but it is possible that a surge or glitch in the power can mimic a command to start moving. If you don't turn off the power, you may find your scope jammed up against the mount or the ceiling of your observatory the next morning. We suggest the following routine. Park the scope and wait for the motors to stop moving. Pull the plug on the battery or disconnect from the power supply. Never walk away from the scope during the parking slew and then forget to remove power.

If you have a permanent observatory with remote operation and are using a 12-volt power supply, we suggest that you turn the power off with some kind of switch. We strongly recommend that this switch cut BOTH sides of the line to prevent any possibility of damage from a nearby lightning strike. If even one wire is connected to the 110-volt line, there is the possibility of a ground loop picking up electrical energy and feeding it into the servo drive. The 12-volt input is filtered and can take quite a bit of energy; however lightning can generate enormous currents in a length of wire that can cause damage.

## Calibrate Menu

You can also access a calibration menu from the Setup Menu, as follows, if you accidentally move the mount and telescope, without removing power, and must re-calibrate. Normally, this procedure would not be used in the middle of an observing session.

1. **Go to Park / Mount Opt. Menu.** (Main Menu → Setup → Park / Mount Opt.)
2. **Choose Calibrate Menu (#4).** You have two choices. Refer to the appropriate sections in the Normal Startup Sequence section.
  - a) N Polar Calibrate
  - b) 2-Star Calibrate

## What if I lose my calibration?

Assuming that the mount itself did not move and you are polar-aligned, you can use the sync function as described under Advanced Features later in the manual. This is the quickest and easiest method.

Alternatively, go to calibrate Menu as described above and follow the N Polar Calibrate or 2-Star Calibrate procedure. Since you will already be polar aligned and your location has been selected, you are simply telling the mount where it is pointing. No further adjustments should be needed. Note; do not use the solar system objects in these routines since the RA/Dec positions change with time.

## Specify Mount Type

This setting is made at Astro-Physics. To check or make corrections, follow this procedure.

1. **Go to Mount Menu.** (Main Menu → Setup → Park/Mount Opt.)
2. **Press 5=Mount Type.** Notice that the number field changes each time you press 5.

**Scroll through choices** - Continue to press 5 to choose: AP1200, AP900, AP600E, AP400. If you own a mount produced by Parallax Instruments or Mountain Instruments, check with them for your proper setting.

Park / Mount Options Menu

**1,2,3=Mount Park**  
**4=Calibrate Menu**  
**5=Mount Type: AP1200**

# TOOLS MENU

## ***Permanent Error Memory Adjustment (PEM)***

Astrophotography and CCD Imaging demand the highest tracking accuracy to obtain pinpoint star images throughout your photographic exposure. You do not need PEM unless you are engaged in one of these activities.

The servo drive electronics contain a very sophisticated permanent periodic error compensation circuit (other manufacturers call this PPEC). Because a majority of the periodic error is due to the RA drive worm and is quite predictable, it is possible to significantly reduce it by simply having the controller “memorize” the corrections you make with your button inputs and automatically play them back for each cycle of the worm. This circuit has some unique features that makes it easy to operate and almost totally foolproof.

Polar align your mount so that you have minimum R.A. and Dec drift. Be sure that the night is steady enough with minimum atmospheric motion, and pick a star near the zenith to minimize atmospheric refraction errors. You must use an eyepiece with a crosshair. The recording process will take about 7 minutes to complete for the 1200 and 900 mounts and 8 minutes for the 600E and 400 mounts. The keypad will display the PEM recording screen for the full 8 minutes. However, the actual recording will only occur for the appropriate length of time for your mount. This timing information is stored in the GTO Servo Control Box.

### **Record Permanent Error Memory**

1. **Select response rate for N-S-E-W buttons at the Main Menu.** For medium power, use 1x, for higher powers use .5x or .25x.
2. **Go to PEM setup screen** (Main Menu → Tools → PEM).
3. **Be sure the PEM state is set to NONE.**
4. **Put star on crosshair.** Place a medium brightness star on the crosshair at moderately high power so you can easily see the R.A. gear drift. Practice moving the star with your N-S-E-W directional buttons to get the feel of guiding. To change the response rate for the N-S-E-W buttons, press +/- button.
5. **Choose Record.** The record cycle will begin approximately 10 seconds later, signaled with a single audible beep. The screen will show “Recording” throughout the entire cycle.
6. **Keep star on crosshair.** During the 7-minute recording period, it is necessary to keep the star on the crosshair using the N-S-E-W directional buttons. Every button input will be recorded. Avoid trying to guide out any atmospheric scintillation since this will add a random noise error into your final guide rate. If an ST-4 autoguider or STV is available, it can be used to guide, and the controller will faithfully remember each error correction that it makes. An autoguider is extremely accurate and will place into memory a very smooth correction of the gear error. A countdown timer is provided for your convenience. You cannot cancel the recording session.
7. **Screen will return to PEM setup screen and you will hear a beep when the recording cycle is complete.**
8. **The PEM state will change to Play upon completion of the cycle.** You can watch the crosshair again to see how accurately your corrections were made. If you are not satisfied with your results, record again using the same procedure.

### **Playback PEM corrections**

Activate the corrections when guiding astrophotos or CCD images if you satisfied with the quality of your recording. When autoguiding, the signal from the autoguider will override the PEM correction as needed. The recording itself will remain unchanged until you record over it again.

1. **Choose Play from the PEM Setup Screen.** The controller will automatically play back the correct portion of the worm gear error at whatever tracking, slewing or directional button rate that you choose.
2. **If you do not want PEM to be active.** Toggle to the NONE setting.

Tools Menu

1=PEM  
2=SmartGuide  
3=Photo Timer  
0=Status

PEM Setup Screen

**PEM Setup**  
**PEM State: None**  
**1=Rec 2=Play 3=None**  
**Press MENU to Exit**

## Special Features

A most valuable feature of this circuit is that it automatically compensates for any drift inadvertently introduced by the operator in the process of recording the gear error. For instance, if the mount was not properly polar aligned in altitude, the right ascension drift rate would be in error. The circuitry automatically subtracts this slow drift from the memory, so that the overall long-term drive rate remains exactly at the sidereal rate. This way, the compensated driving rate will always be correct for any other position in the sky and for any other time that the mount is set up in the field. When the mount is properly aligned, it is possible to take 15 to 30 minute unguided astrophotos without trailed star images. For more critical exposures, the controller memory allows the astrophotographer to check the guide star only occasionally during a long exposure.

## Photographic Timer

Activate the countdown photographic timer to remind you when your exposure is completed. An audible beep will alert you that the time has expired.

Photographic Timer Setup Screen

1. **Go to Photographic Timer Setup Screen.** (Main Menu → Tools).
2. **Choose Photo Timer.** The Photographic Timer screen will appear.
3. **Enter hours, minutes and seconds.** The timer will activate.
4. **When the timer reaches 0, a series of audible beeps will sound.** The display will begin to show negative numbers to let you know the time that has elapsed since the timer went off.
5. **Press MENU to cancel timer at any time.**

```
Photographic Timer
Enter hh:mm:ss now
Timer: 00:00:00
Menu=Exit
```

## SmartGuide

Smart guide is a new variable tracking rate tool for your Astro-physics GTO mount. It can be found in the tools menu (#3) in the version 4.x firmware.

SmartGuide Main Screen

```
1=R:EST 4/5=RM:1000
2=D:NOR9/0=DM:1000
3=S:1 6/7=PE :1000
Goto / Menu / More >
```

### Why do I need SmartGuide?

The sky unfortunately does not move at precisely the same rate of motion everywhere, nor is a perfectly precise polar alignment easy to obtain. Both of these factors can contribute to mount motion that is slightly off the sidereal rate of motion. With today's CCD cameras these challenges for precision are bigger than ever. Also some object such as the moon, asteroids, and comets do not move at the sidereal rate, therefore SmartGuide can reduce the guiding errors on these objects.

### How does SmartGuide work?

One way to compensate for changes in the motion of the skies is to introduce small corrections into the motion of the mount to cancel out the effects of a less than perfect polar alignment or variability in tracking due to atmospheric refraction. These corrections are done in the keypad software by periodically sending short pulses of movement to the mount in the axis that needs the adjustment. This effectively compensates for almost any kind of drift.

### How do I use SmartGuide?

To use smart guide you will need either a CCD camera or a crosshair eyepiece

- Make sure your PEM is recorded and active if you wish to use PEM to reduce periodic error. It cannot be accessed once you go into Smart Guide.
- Select a bright star or object near the area you wish to image.
- Enter the smart guide menu by hitting #3=Tools on the Main Menu, then select option 2=SmartGuide. Press the NEXT> button to move to the More Menu.
- Take note of the button speed setting. We recommend making your adjustments at 1x button speed or slower. Button speed can be adjusted by pressing the +- button to bring up the speed setting.
- Press #1 on the pad to enter Auto Smart Guide setup.
- When using image-processing software, center the star with the assistance of the cursor or cross hair on your computer screen (or crosshair if you are using an eyepiece) and press 1 to activate the smart guide recording.



- Let your mount run for 5-10 minutes then go back and precisely center the object on the screen (or crosshair if you are using an eyepiece).
- Press #1 as soon as you have the object centered again.
- The keypad display will now show 5 significant numbers on it.
  - RM: - The amount in arc seconds the mount has moved in RA
  - DM: - The amount in arc seconds the mount has moved in DEC
  - Time: - In seconds that you recorded your measurement
  - RS: - The amount of RA drift per second in arc seconds RM/Time
  - DS: - The amount of DEC drift per second in arc seconds DM/Time
- These are the values that SmartGuide will now use to compute the button on time, in milliseconds, to track the object at the chosen tracking rate.
- Hit GOTO to start SmartGuide running.
- The keypad display will now show the following. The asterisks will blink as the pulses are delivered.
  - R: - The movement direction in RA
  - D: - The movement direction in DEC
  - S: - Speed
  - RM: - Length of pulse in milliseconds sent to the RA axis
  - DM: - Length of pulse in milliseconds sent to the DEC axis
  - PE: - The length of wait time between pulses
- Setup your CCD or camera and image away.

Auto SmartGuide Data Screen

```
RM:  0  RS:0.00000
DM:  0  DS:0.00000
Time:   90 Secs.
Press Goto Now
```

SmartGuide Run Screen

```
1=R:EST 4/5=RM: 120*
2=D:NOR9/0=DM:  70*
3=S:1   6/7=PE:1000*
Hold Stop to Exit
```

### Is SmartGuiding better than Auto Guiding?

Auto guiding is always more accurate than matching drift rates with SmartGuide. It would always be the preferred method except in circumstances where a guide star is not available (filtered shots, star-poor regions, H-alpha imaging etc.). Matching drift rates with SmartGuide is akin to setting your car's speed on cruise control and trying to match exactly the car in front of you who also has his set on cruise. If you don't adjust your speed from time to time (i.e. guiding), eventually you will either hit him, or drift farther apart. It's even more difficult if the car in front is slowly increasing or decreasing his speed.

If you plan to use your computer to control your mount, consider using PulseGuide, by Ray Gralak of Sirius Imaging. This program will simulate all functions of your keypad for remote control of your telescope, including PulseGuide, which is similar to SmartGuide in its function. PulseGuide is available as a free download from the Astro-Physics website.

## Status

If your mount stops functioning, you can get an idea of possible causes by checking the status. Information pertaining to the program code level and database level is also displayed here.

When you press 0=Status in the tools menu, the screen will display "Press North Key to check mount status." When you do this, the keypad probes the motors at 64x (please note that your button rate will then change to 64x). These are the possible messages you may see when you check the status:

- Code level version # (refers to the actual program)
- DB level version # (refers to the database)
- All Systems Go
- Motor Stalled – This may be due to a stalled motor, mount cable not connected properly, broken wire connection in a mount cable or motor box, worm gear jammed too tightly against worm or foreign

particle in gearbox, which jammed the teeth of a gear. Please call Astro-Physics for help correcting this error.

- Low Battery – When your 12V power source dips below 11V, this message will appear. At this point, the battery has approximately 5% of its energy, which is not enough to power the mount.

## SLEWING DURING THE DAY

You must take extra precautions when observing during the daytime. ***If not done correctly, you may suffer permanent damage to your eyesight.*** Be sure to supervise all children and other observers who may not be aware of the dangers.

Observing in the daytime offers many rewards - finding the planets and stars, and observing sunspots and solar prominences of the sun itself.

### ***Potential Dangers***

- As the telescope is slewing from one part of the sky to another, it may pass across the face of the sun or near enough so that looking through the telescope would be dangerous unless you have a proper solar filter. **DO NOT LOOK DIRECTLY INTO THE TELESCOPE OR VIEWFINDER WHILE THE TELESCOPE IS SLEWING.**
- The position of the planet or star that you wish to see may be too close to the sun to observe safely. **CHECK THE POSITION OF THE TELESCOPE BEFORE YOU LOOK INTO THE EYEPIECE OR VIEWFINDER. BE SURE THAT IT IS NOT POINTING AT OR ANYWHERE NEAR THE SUN.** Remember that the finder has a wide field of view so you can see a large portion of the sky.
- **PLEASE DO NOT OVERRIDE THE SUN SAFE ZONE DURING THE DAY.** This feature is in the keypad for your safety.
- Observing the sun. Be sure that you have installed a good quality SAFE solar filter that covers the optics in front of the telescope. Never use eyepiece filters since they may break due to the intense heat of the sun. Do not use solar filters that are cracked (glass), torn (Mylar) or have many pinholes (either glass and mylar). If you use a photographic solar filter, be sure to use an additional neutral-density filter when viewing through and eyepiece or the viewfinder of your camera.

### ***How to Observe Safely***

1. Place dust cover or proper solar filters on the main objective of the telescope and the finder scope before you slew the telescope, use the N-S-E-W directional buttons or move it manually. Be sure to inspect your solar filter beforehand to be sure that it is not damaged in any way that will allow light through. Use a black marker to cover the pinholes that may appear in the coating.
2. Slew or move the telescope.
3. Visually check the position of the telescope to be sure that it is not pointing at or anywhere near the sun.
4. If you are observing planets, the moon or stars - remove the dust cover or filter only when you are sure that it is safe.
5. To observe the sun - ALWAYS leave your solar filter in place over the front of the objective and finder.
6. Put the solar filters or dustcovers back on the telescope before slewing to the next object.

# ORTHOGONALITY

A telescope is said to be orthogonal when its optical axis is exactly 90 degrees from the declination axis as shown in the photo. In alt-az fork mounts, orthogonality is not an issue. Pointing is straightforward, the scope never has to flip sides and the mount does not need to be polar-aligned. However, in German equatorial mounts, a non-orthogonal telescope will cause errors in any routine that uses the scope for polar alignment (such as the N Polar Calibrate routine) and will reduce the pointing accuracy of the system by exactly twice the orthogonal error.

Telescope orthogonality requires two conditions be met:

1. The RA and Dec axes of the mount are at precise right angles to each other. Astro-Physics mounts are very accurately machined and fulfill this condition.
2. The optical axis of the telescope must be parallel to the RA (polar) axis. Some of the factors which could affect this condition include:

- Improperly machined rings.
- Wedge in the mounting plate or brackets.
- Incorrect position and tilt of a diagonal mirror or diagonal assembly that is not machined square.
- Set screws in focusers, diagonals or adapters which tilt the optical axis.
- Die-cast tube assemblies that lack the precision squareness of a CNC machined part. The tube points in one direction while the optics can point several degrees off in another direction.
- Diagonal displacement or tilt in a Newtonian.
- Mirror shift in a catadioptric. The optics are not tied down to a reference plane, but can move around and point in different directions depending on focus position.
- Collimation adjustment. There is enough freedom in the tilt of a secondary mirror to allow the image to be moved completely out of the eyepiece field. Therefore, collimating the scope may disturb or change orthogonality.

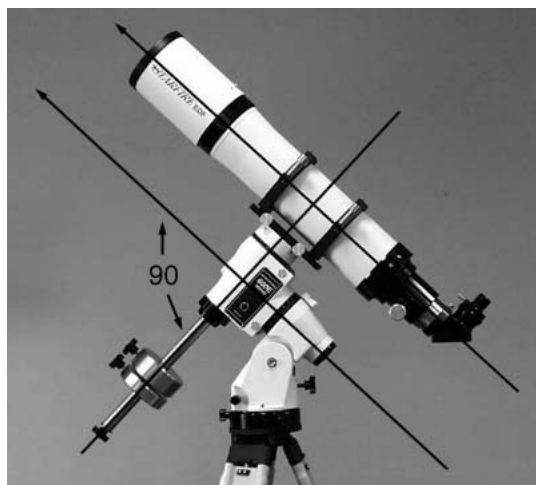

*The optical axis must be parallel to the polar axis and 90 degrees to the declination axis*

Whatever the reason, orthogonality can be easily checked and adjusted, if needed.

## Check Orthogonality

To do an orthogonal check, the mount should be close to polar aligned, however the alignment does not need to be perfect. Next, you need to slew between two stars that are straddling either side of the meridian.

For instance, in early summer at 9 p.m. (northern hemisphere), the constellation Boötes is straight up and Alpha Boötes (Arcturus) and Epsilon Boötes are on either side of the meridian. Follow this procedure using a crosshair eyepiece:

While Arcturus is not a suitable star to use in the N-polar alignment routine, it works well in this application.

1. **From Objects Menu, select Tours.**
2. **Choose Stars/Constell and scroll to “Cons:Boo”.** (If the stars you want to use are listed in the common star names list, you can choose Strs from the Objects Menu and select the stars from that list).
3. **Choose “alf”.** The magnitude will display.

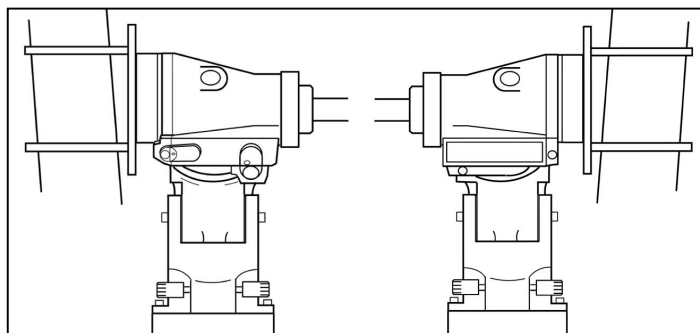

*Exaggerated illustration of error caused by mounting rings with varying thickness at base of ring. Shows how scope will not point to desired target and the displacement that will occur on either side of mount.*

4. **Press GOTO.** The scope will now slew to Arcturus in the west.
5. **Center the star on crosshair using your N-S-E-W buttons.**
6. **Press the RA/DEC/REV Button**
7. **Press 9=Re-Calibrate.** You will hear a beep letting you know you re-calibrated. This will re-calibrate your scope precisely on Arcturus.
8. **Return to Tours.** In this example, the constellation Boötes will display since you are now pointed to it.
9. **Choose “eps”.**
10. **Press GOTO.** The scope will now slew all the way around the dec axis to point east to Epsilon Boötes. If the polar alignment was not exact, the new star will appear displaced north or south in declination. Ignore that error for the moment (you can bring the star back in Dec with the buttons, but NOT R.A). The amount that the star is displaced in R.A. will be equal to twice the optical tube assembly orthogonal error.
11. **Correct orthogonality.** Simply shim up one of the tube rings to bring the star *half way* toward the crosshair. You can use commercially available shim material from your hardware store or pieces cut from a soda can.
12. **Center the star with the N-S-E-W buttons.**
13. **Press the RA/DEC/REV Button**
14. **Press 9=Re-Calibrate.** You will hear a beep letting you know you re-calibrated.
15. **Slew back to the first star.** Add additional shims as necessary (or adjust your optics if that is the problem) until both stars appear on the centerline of the crosshairs.

This procedure can be carried out on the SAME star for even more accuracy by using the Meridian Delay feature. For instance, point the scope to a star within 1 hour of the meridian, then advance the meridian delay by 1 hr E. Slew to the same star. This time, the scope will point to the star from the other (east) side of the mount.

## ***Effect of Non-orthogonality on Polar Alignment***

The whole idea of polar alignment is to achieve drift-free tracking. Therefore, it is the mount that needs to point to the pole, not the optical axis of the scope. When the optics are not orthogonal, you cannot use the scope to point accurately near the pole. As an example, if the scope had a 1 degree orthogonal error, the mount would be off by 4 minutes in R.A. at the celestial equator, about 8 minutes in RA at 80 degrees Dec, and a whopping 6 hrs in RA at 89 degrees Dec. Anything beyond 89 degrees cannot be reached at any orientation of the mount. Therefore, when the scope has an orthogonal error, it is useless to try to polar align using Polaris or any star near the pole.

## ***Polar Alignment with Non-orthogonal Telescopes***

In this situation, a 2-step method to align the mount is recommended. Choose 2 stars with nearly the same RA on the same side of the mount. Do not use 2 stars where the mount has to flip sides. Avoid stars above 60 degrees N or S. As an example, in the summer we have Vega in the north and Nunki (αSag) in the south. Using the 2-star alignment, select one as a pivot star, and use the other to adjust the azimuth axis. To set the altitude axis, choose a 3<sup>rd</sup> star different in RA and Dec, such as Enif (εPegasus) and slew back & forth between it and Nunki.

**Very Important:** You must point to stars in the west when your telescope is on the east side of the mount and stars in the east when your scope is on the west side. When the stars are high and close to the zenith, this can be tricky. However, you can tell which side the star is on by looking at the “z” number in the upper right corner of the Choose Star screen, then comparing that number with the RA number of the star you choose. If the RA number is larger, the star is in the east. If your scope is not on the correct side, the mount will not slew properly and the telescope could strike the pier/tripod.

For a more foolproof way to adjust the altitude, you can pick a constellation on the meridian and slew back & forth using the Stars Tour mode. If conveniently placed, stars of the same constellation, e.g. alpha, beta etc., can be on either side of the meridian. Slew between them will cause the telescope to switch sides, and any Dec error corresponds to twice the altitude movement you must make on the mount. RA error will show you how far out your orthogonality is. This only takes 1 or 2 iterations to get very close alignment of the optical axis. Roland personally uses a variation of this method, using the same star. By advancing the clock by 1 hour or using the meridian swap feature, the scope will slew to the west side of the mount, where a precise compensation can be made to the altitude axis. This avoids any discrepancy in RA and Dec co-ordinate data.

Using our Polar Alignment Scope (part # PASILL3) is another alternative. It is easier and quicker than either of the above methods. However, keep in mind that the Polar Alignment Scope must also be aligned with the mount so that it is orthogonal. Once this is done in the first session, subsequent polar alignment will be very quick.

## ***Additional Tips for Non-Orthogonal Systems***

Additional suggestions for improving pointing accuracy and living with non-orthogonal systems are provided in these prior sections of the manual:

- Using Tour Mode to Compensate for Imperfect Polar Alignment or Non-Orthogonal Systems.
- Using Software to Improve Pointing Accuracy.

# ADVANCED FEATURES

## *Sync Function*

Sync is used typically at the start of an observing session. Sync calibrates the mount on a known object in the database, one to which you have positioned your telescope manually. Sync assumes that you have placed your telescope on the proper side of the meridian, i.e. a telescope placed on the west side of the mount pointing to a star in the east. This assures that the telescope will be positioned on the proper side of the mount for all subsequent objects. These are typical uses of Sync.

### **Startup- Your mount is polar aligned and Auto-start is set to “no”**

1. The Site Menu will display when you power up the mount. If you had not parked, the mount will start tracking in R.A. immediately. However, if you had parked in positions 1,2 or 3 at the end of the last session, the mount will NOT start tracking until you choose your location from the site menu.
2. Choose your location. This will send location, date and time information to the mount. The Sync, Align, and Resume Menu will now appear.
3. Point your telescope to a known bright star or solar system object. Center it in the eyepiece. (If the object drifts, you will know that you are not truly polar-aligned).
4. Select 1-Star Synch and scroll through the common star names until you find the one that is centered in your eyepiece. The solar system objects are at the end of the list. Remember, you can use the <PREV button to scroll from the back of the list.
5. Select your target object and then press GOTO. This will sync on the object. The mount will not actually slew anywhere. The Main Menu will appear. Begin observing.

### **Startup - Your mount is polar-aligned, Auto-start is set to “yes”, however the telescope has been moved**

1. The Main Menu will display when you power up and the mount will start tracking (whether you parked at the end of the last session or not).
2. Point your telescope to a known star or solar system object. Center in the eyepiece (if the object drifts, you will know that you are not truly polar-aligned).
3. Go to Objects → Strs.
4. Select your target object. The Cal Star Menu will appear for that object. Note the “>” sign in the upper right corner.
5. Press >NEXT and the Sync menu will appear.
6. Double check to be sure the object is still centered. Press 1=Sync current object and Menu to exit.
7. Note: Alternatively, you may sync through the Stars/Constellation routine. It is also possible to sync on Messier, NGC, IC, Abell galaxies, ADS double stars and Objects/Constellation; however since these objects are not discrete points (or have two points, as in double stars), they are not the ideal choice for syncing.

### **Your mount is polar-aligned and you were moving the telescope manually to look at a few objects before slewing with the go-to feature**

Use the same procedure as above, beginning with step 2.

## *Tweak Your Pointing Accuracy*

You slew to an object and center it in your eyepiece with your N-S-E-W directional buttons. You have two choices, either sync or re-calibrate. Both are possible, however re-calibrate is easiest and involves the least number of keystrokes.

### **Sync**

Let's say that you slew to M1, then, by hand, center the object in your eyepiece. Return to Messier Number screen and enter 1 again, however this time, select the >NEXT button which will display the Sync menu. Press 1=Sync Current Object and MENU to exit. Remember that syncing on diffuse objects is less accurate than more

discrete points, however if your target object is obviously at the edge of the field, centering to the best of your ability gets you closer. Sync is also described in the previous section.

### **Re-calibrate**

Re-cal is used to re-calibrate the position of the mount if an object does not appear in the center of the field. Re-calibrate can be used even when the object is past the meridian and the telescope is below the mount. Re-Cal recalibrates on the last object to which the telescope was sent.

In the same example as above, slew to M1 and center using N-S-E-W buttons. Simply press the RA/DEC REV button and select 9=Re-Calibrate.

Note: You can only use the recalibration option if the keypad has the target object in its memory, i.e. you just gave a slew command and the keypad already knows it should be at that object. You cannot use this option if you manually move the telescope to another position, since the keypad would have no way of knowing what that object is. In this situation, use sync as described above.

## **Meridian Delay Function**

**This function should be used with caution to prevent accidental telescope contact with the pier.**

In normal use, the telescope will track through the meridian when you are following an object. However, when you enter the object again, or if you enter a nearby object that has drifted past the meridian, the telescope automatically switches sides so that the scope will be "right side up" instead of diving under the mount. Sometimes, for astro-photography, you may wish to delay the meridian swap, especially if you are imaging mosaics and the area is beginning to drift across the meridian.

To delay the swap, press the button marked RA/ DEC/REV. The last menu item is the meridian, set normally to zero. By using the PREV< and NEXT> buttons you can enter a 1 hour to 6 hour delay or advance of the meridian swap. A setting of 1W means that the scope will continue to slew to objects up to 1 hour past the meridian in the west. It effectively delays the meridian sway by 1 hour. A 6 hour delay means the scope will slew all the way to the horizon on the "wrong" side of the mount. Entering a 1E means that the scope can be placed on the other side of the mount by 1 hour earlier than normal.

When you turn the power off, the meridian hour offset will return to the default setting of "0W." You will have to make a conscious decision to change it during each observing session. If you are permanently mounted and leave your power on, be sure to remember that you have made this setting. We encourage you to return to "0W" at the end of your observing session.

Note to programmers: The meridian delay is accomplished by sending a time to the mount that is from 1 up to 6 hours different than the clock time. 6 hours plus, delays the meridian to the east, 6 hours minus delays the meridian to the west. So, if you want to delay the meridian from your computer terminal, just send the revised time to the servo drive per the AP protocol. Caution: If you park the mount with this fake time and turn off the power, then unpark it later, the mount will point at the wrong RA. It will be off by the amount you faked. If you are going to send a fake time to the mount with your computer, then make sure you reset to the correct time before you park the mount and turn off the power.

## **SmartGuide**

Refer to the section in the Tools Chapter for details pertaining to this feature.



# UNDERSTANDING THE KEYPAD CONTROLLER AND GTO CONTROL BOX FUNCTIONS

## *Functions of the GTO Servo Control Box*

These notes apply to the GTOCP1, GTOCP2 and GTOCP3 models of the control box. The model number is silk-screened on the face plate of the box.

The main function of the servo control box is to drive the RA and DEC motors. The motors are DC servos with built-in shaft encoders. The rotation rate of the motors is controlled with a servo feedback loop. The servo looks at the return pulses from the shaft encoders and adjusts the current to the motor so that the rate is identical to the commanded rate (i.e. from .25x sidereal to 1200 x sidereal). The servo is digitally controlled, and the shaft position is updated at a rate of 2000 times per second.

The central computer in the servo is a microprocessor that converts input commands to electrical signals to move the motor. The input commands are in the form of the AP protocol, eg. :Sr 02:45:32.5# which would define a move position of 2hr 45min 32.5sec in right ascension. The microprocessor converts those numbers to specific shaft angles of the two axes, and determines whether the telescope should access that position from the east side or west side of the mount. The servo responds to commands to move in RA or DEC when any of the 4 buttons are pushed, according to the rate set on the keypad (from .25x to 1200x). The servo will also initiate movement in the 4 directions from inputs sent to the CCD guider port at rates set by the keypad, typically 1x, .5x or .25x the sidereal rate.

The servo microprocessor stores vital date, time and location information sent to it from the keypad, or a planetarium program via one of the input ports. It stores worm periodic error information (PEM) so that it can be played back when required for high-accuracy tracking.

The main function of the servo control box is to convert input data from the keypad or a planetarium program (in the form of the AP protocol) to electrical signals to the motor to produce the desired motor motion and to result in the telescope pointing at the desired object in the sky.

## *Functions of the Keypad*

The keypad controller is really a small hand held computer with planetarium software. It has a database for tens of thousands of objects that can be accessed by keypad entry or scrolling through a menu.

To orient the system properly with respect to the sky requires date, time and location information. The keypad contains an accurate date and time clock powered by a lithium battery. Together with the location data that is entered by the user, the keypad uses this information to calculate what part of the sky is up at any given time. The keypad also sends this information to the servo controller to calculate where the horizon limits are, and where the meridian line is located. This prevents the scope from pointing into the ground and allows the servo to do a meridian swap so the tube assembly does not dive under the mount and hit the pier.

The main function of the keypad is to send RA and DEC numbers to the mount for the objects that the user enters into the keypad. This is exactly the same as the functions of a typical planetarium program. In fact, most of the keypad functions can be replaced with those contained in PulseGuide by Ray Gralak, Digital Sky Voice or an advanced planetarium program, like The Sky Level 5 from Software Bisque. You can therefore disconnect the keypad entirely from the mount without losing any of the functions of the mount including parking, jogging, centering or moving to various parts of the sky. You can also control things like focus motors and reticle brightness from your desktop computer. Not all planetarium programs support all of these functions; please check the features of the program you are considering.

We have separated the functions of the servo control box and keypad to allow for maximum flexibility to the user. The servo is a stand-alone unit that can be controlled entirely by the keypad, by a desktop computer with a suitable planetarium program without the keypad, or with both keypad and desktop attached.

## ***Upgrading the GTO Servo Control Box***

Upgrades to the logic of the GTO control box (GTOCP1 or GTOCP2 models) are made by installing a new ROM chip, since the chip is housed in a removable carrier, the old one can be popped out easily and the new one eased into place.

We decided that we couldn't allow Internet updates to this chip because unfriendly and unauthorized people could pirate the software. We have worked too hard on its development to give it away. We hope you understand.

## ***Upgrading the Keypad***

The keypad has flash RAM memory. Version 4.x and future versions of the keypad firmware will be available through an Internet download. The GTO control box must have a version "C" or higher version of the micro-controller chip in order to accomplish the Internet download. The version number is written on the chip and was issued after January 22, 2001. Refer to the technical support section of our web site for additional information.

## ***Upgrading or Repairing the Keypad Database***

The object database is stored in a separate memory location within the keypad than the control firmware. It is stored in memory which is powered by a small 3V Lithium battery. Should this battery fail, the database become corrupted or a new database become available, you can upgrade or repair your database using a utility found in the technical support section of the Astro-Physics website. The GTO control box must have a version "C" or higher version of the micro-controller chip in order to accomplish the Internet download. The version number is written on the chip and was issued after January 22, 2001. You may wish to refer to the technical support section of our web site for additional information.

# TROUBLESHOOTING

Additional tips related to specific mounts are in the mount instruction manual.

## ***The keypad displayed the message “motor stall.”***

This error message indicates that the keypad and servo box are unable to communicate with each other. If the mount was shipped after February 16, 2000, the LED on the control box will also turn yellow, indicating that the overload protection feature has been activated. Although older mounts do not have the yellow LED, the overload protection feature is active. These are the conditions that will cause the error message:

- Your telescope is not balanced properly. Refer to your mount manual for guidance.
- The motors are not connected to the servo box. Be sure all connectors are locked in place.
- A wire connection in one of the mount cables is broken.
- One of the motors is not functioning.
- The mesh of the worm gear and worm wheel is too tight. This will cause the motors to overload, which will cause the overload protection feature of the servo box to activate and shut down the signal to the motors.
- The microprocessor chip, which contains the program logic, is missing from the servo box.
- One of the small gears in the motor box of the 1200 or 900 is jammed.
- Foreign material got into the motor gearbox.

### ***Solution:***

Check all possibilities above and correct, if possible. To initiate tracking again, press the N-S-E-W buttons, initiate a slew or go to Main Menu and press “0” Status (if you still get an error message, press the button a second time, just to be sure that the buffer cleared). If you have not moved the telescope while diagnosing the problem, the position will still be in memory and you can continue as if nothing ever happened.

If the “motor stall” message appears again, you have not corrected the cause of the problem. If you are unable to resolve it, check the technical support section of our website before contacting Astro-Physics. Additional troubleshooting and adjustment information will be posted there in the future.

## ***The keypad display says “low battery.”***

Your battery output has dropped below 11 volts. If you plug in your Kendrick heater, CCD camera or other power-hungry device into the same battery that operates your mount, your battery voltage will drop momentarily. We recommend that you power your mount from a separate battery. You might consider a large marine battery. If 110V is available, we recommend that you use a power supply (filtered and regulated) with a minimum output of 5 amps at 12V DC. DO NOT use a wall-transformer.

## ***The keypad locks up on the “Astro-Physics” screen and will not advance to the next screen.***

There are several conditions that may cause this to occur.

- Battery power has dropped. If you measure the output of your battery to be above 11.5V, but the keypad is locking up, please contact Astro-Physics. If your battery measures below 11.5V, recharge or replace your battery.
- Recent lightning strike or power surge damaged components in the control box. The control box will have to be returned to Astro-Physics. Please call ahead for a return authorization number.
- Other unknown chip failure in the control box. Contact Astro-Physics.
- The keypad was loaded with version 4.12 with Auto-Connect set to yes and keypad was not reset to default values. This may have occurred during programming at Astro-Physics or following an internet download before this issue was discovered. To remedy, refer to the Technical Support section of the website and read the revised instructions pertaining to the 4.12 upgrade.
- Keypad locks up in cold weather but works fine when used in warmer temperatures. This is a rare problem caused by a defective real-time clock in the keypad. Contact Astro-Physics.

- Corroded circuit board in the keypad.

### ***The keypad display text blinks on and off, but there is no clicking sound.***

- Battery power has dropped below the required threshold. If you measure the output of your battery to be above 11.5V, but the keypad is still blinking one and off, please contact Astro-Physics. If your battery measures below 11.5V, recharge or replace your battery.

### ***The keypad is resetting – making a clicking sound as the screen display disappears and reappears***

If Auto-Connect had been set to NO, the Location Selection Menu will appear each time requesting you to startup again. If Auto-Connect had been set to YES or EXT, the display will reappear wherever you left off. The clicking noise will be annoying, but you will not lose functionality.

There are several potential causes and detailed solutions, which are outlined on our website in the Technical Support section.

### ***The RA drive makes random movements and jumps in position as it is tracking.***

- It is possible that someone programmed the PEM correction in a random manner. Check the PEM setup screen to see if the PLAY setting is active. If it is, change the setting to NONE and observe the action of the mount. This is most likely to occur when a group of people use the mount and one experiments unknown to the others. To remedy, leave the setting to NONE until a proper PEM recording is made.

### ***The telescope slewed in the wrong direction toward the pier.***

As long as you provide the mount with proper information, your telescope will slew safely from one part of the sky to another. These are a few scenarios that can cause a problem:

- You did not start your first session at that location by following the Normal Startup Procedure outlined in the manual.
- Your time or daylight savings is not set correctly (if it applies to your state or country). In the location menu, press the “0” number button if daylight savings is not in effect (e.g. winter). Enter “1” if daylight savings is in effect (e.g. summer). Remember to change this when we “spring forward” or “fall back”.
- When you selected your calibration star, the scope was set up on the wrong side of the mount. Or, in conjunction with the daylight savings issue, if the daylight savings is set incorrectly and you choose a star near the meridian, the scope may be on the wrong side of the mount according to the time set on the keypad.

You must point to stars in the west when your telescope is on the east side of the mount and stars in the east when your scope is on the west side. When the stars are high and close to the zenith, this can be tricky. However, you can tell which side the star is on by looking at the “z” number in the upper right corner of the Choose Star screen, then comparing that number with the RA number of the star you choose. If the RA number is larger, the star is in the east. If your scope is not on the correct side, the mount will not slew properly and the telescope could strike the pier/tripod.

- You identified a star incorrectly when you selected it.
- Your time setting sent to the mount by the computer may be inaccurate.

### ***I pressed the keypad button and it jumped ahead two steps.***

This happens if you hold the button too long. Just give it a short press.

### ***The power light goes out and the motors stop.***

The voltage of your battery has probably gone below 10 volts.

### ***The motors moved when I disconnected one of the cables.***

This is caused when the contacts of the connectors disconnect briefly, then reconnect again as you remove the cable. We recommend that whenever you disconnect any of the cables, you do so quickly with a firm outward movement.

### ***The scope got lost when I tried to set the keypad to UT (universal time).***

The mount MUST be set to local time. Otherwise it places the meridian at some place other than straight above you. RA and DEC is fixed for any object (except the solar system), but the RA time for the zenith is tied to local time. This is the only way the mount knows whether an object is in the east or west, and consequently what side of the mount your scope ought to be on.

### ***I parked the mount last night, but it started moving again.***

Please read "Parking and Power Considerations" under the Parking Your Telescope Section.

### ***The Time/LST Screen doesn't exit right away when I hit the menu button.***

Please push and hold the menu button until you are brought back to the main menu. A quick push may not be recognized right away in this menu due to the way the time software is handled.

### ***The Keypad doesn't save my data when I press the MENU button to leave the entry screen.***

Due to the change in the way the cursor control works from Version 3.2 and lower, you MUST press the GOTO button to save your data, i.e. location or date/time. Pressing the MENU button will exit the screen and lose any data you entered. This change was made to accommodate the full cursor control enabled by pressing the <PREV and NEXT> buttons.

The GOTO button now acts like the ENTER or GO button on a computer or web browser and the Menu button acts like the ESC or BACK button on a computer or web browser.

### ***The Keypad will not accept my location data I received from my GPS or a Website.***

Many websites and GPS units return your location in a decimal number of Lat and Long

i.e. 42.3589 Latitude 89.0409 Longitude

The keypad's input is in Degrees, Minutes, Seconds

i.e. 42° 21' 32" Latitude 89° 02' 27" Longitude

If you were to type the decimal data into your keypad it would give you an error message. This happens because the decimal number is not equivalent to the Degrees, Minutes, Seconds format. The 4.1x keypad has error checking that will not allow more than 60 minutes or 60 seconds to be entered. It is possible to have inaccurate location data in your mount if none of the degrees were over 60.

Please double check your location data to make sure you entered it in the correct format.

Here is a link to a free online converter that will give you the proper format for entry into your keypad.

<http://www.fcc.gov/mb/audio/bickel/DDDMSS-decimal.html>

### ***The Mount will not park correctly, nor will it point properly, it also indicates that an object is below the horizon when I can clearly see it is not.***

This can occur if you did not enter your location, date and time data and follow the Normal Startup Procedure. Every time you start up at a new location or change your time, you must follow the Normal Startup procedure to send vital date, time and location data to your mount.. Otherwise, it will be lost.

### ***I am trying to upgrade my keypad and the loader is telling me that it finds the mount but the firmware is the incorrect version.***

There are few possible causes:

The first is that your control box firmware is in fact a version that does not support online Keypad upgrades (Version B or lower) Please call Astro-Physics to get your chip upgraded.

The second is that your computer is set to an incorrect COM port and is communicating with another device on your COM port, most commonly a modem. Verify your COM port settings with another program like PulseGuide or the Sky to make sure that you have communication with the mount. Check the COM port setting in the program and make sure the same COM port is selected in the keypad loading program.

***I am upgrading my keypad from the website and the loader appears to be working but no data is appearing on the screen other than sending page x...***

In most cases this is caused by attempting to load the keypad through the bottom port on the control box. The keypad MUST be loaded through top COM port on the control box or the load will fail. If you have already attempted to load your keypad in this manner and are only left with a blinking cursor on the screen, you can start the loading steps from the start and your keypad will load properly. Please follow all download instructions very carefully.

***When I enter an object it slews to the wrong place, tells me that it is below the horizon by several degrees and has completely incorrect object data.***

If all 3 of these symptoms are occurring it is likely that your keypad's database has been corrupted or lost. Many things can cause this to happen, removing the internal keypad battery improperly, having a dead or dieing battery or power surges caused by lightning strikes are all common triggers for this. To reload your keypad's database you will need to download a utility from the Astro-Physics website to repair your database. If the database continues to fail after you have reloaded it, please call Astro-Physics for further instructions.

# USING *THESKY*<sup>™</sup> SOFTWARE V. 5.00.014 OR LATER

These instructions are based on Software Bisque's *The Sky*<sup>™</sup> version 5.00.014. *The Sky Astronomy Software* is a trademark of Software Bisque. The micro-controller chip in your GTO control box must be dated November 13, 2000 or later in order to access all of these features. Check the date by opening the top of the GTO control box and looking for a label on one of the large, square chips. If your chip is not dated at all, it was probably programmed prior to July 1999 and is an early version.

Note: Please see the External Startup Sequence and the Get Time and Location from Mount sections for new ways of synchronizing your keypad, mount and computer. Also check [www.bisque.com](http://www.bisque.com) for information on later upgrades.

## ***Polar Alignment***

The telescope must be polar-aligned to slew accurately. This is easiest to do if you have a polar alignment scope or use the routine in the keypad.

## ***Hardware Setup***

- 1) **Plug the computer cable into one of the RS-232 ports on the GTO Control Panel** (it doesn't matter which one). Use a straight-through computer serial cable with a 9-pin connector on one end (to attach to the servo box of the mount) and a connector that will attach to the serial port of the computer that will be used. Determine which COM port is available on your computer
- 2) **Plug the other end of the cable into your computer.**
- 3) **Plug power cord into GTO Control Panel on the mount. Be sure all of your motor cables are locked in place, as well.**

## ***Software Setup***

Turn on your computer and open *The Sky* software. These instructions assume that the keypad is NOT plugged in.

- 1) **Setup Site Information.** You can skip this if you have already entered the information in a previous session and it has not changed.
  - a) **Click DATA in the menu bar.**
  - b) **Click SITE INFORMATION.**
  - c) **Enter your location, date and time information.**
  - d) **Click OK or APPLY and CLOSE.**
- 2) **Set telescope type.**
  - a) **Click TELESCOPE in menu bar.**
  - b) **Click SETUP.** The Telescope Setup box will appear.
  - c) **Select "Astro-Physics GTO German Equatorial Mount."**
  - d) **Click SETTINGS.**
  - e) **Choose the COM port that you are using on the computer and set the baud rate to 9600.**
  - f) **Click OK; select any other display options that you prefer.** Refer to the manual provided with your software.
  - g) **Close the Telescope Setup box.**
- 3) **Link mount to *The Sky***
  - a) **Click TELESCOPE again.**
  - b) **Click LINK and ESTABLISH.** A crosshair circle will appear on the star map.

- i) **GTO control box chip dated November 13, 2000 or later.** If you parked your mount with *The Sky*, the white crosshair circle will point to the position that you had selected to Park (even if you turn the power off between sessions).

Even if you didn't park with *The Sky* in the previous session, this chip will remember the position of the mount when the session ended (auto-park feature). As long as you have not moved your telescope, this position will still be correct and you are ready to begin observing. If the scope was moved, follow the Sync procedure below.

- ii) **GTO control box chip dated prior to November 13, 2000.** If you had parked with *The Sky* in the previous session and the power to the mount has remained on, the white crosshair circle will indicate your park position. If the power is turned off, the mount will NOT retain this information in its memory (it does not have the auto-park feature). Note, if you had parked with the keypad you must un-park with the keypad to gain the benefits of parking.
- 4) **Initialize your telescope.** This step is no longer necessary for any GTO mount. However, if you get the error message "No response from the device. Error code = 203 0xcb), " when attempting to synchronize or slew the telescope (but can see the cross hairs on the screen), try initializing the mount using the Initialize command before continuing. Click Telescope | Options | Initialize to initialize the control system's date, time, time zone, latitude and longitude.
  - 5) **Synchronizing the mount with *The Sky*.** This procedure is only necessary if your telescope is not pointing to the position indicated by the white crosshair circle when you establish your link. By syncing, you will tell *The Sky* where your telescope is pointing.
    - a) **Point your telescope to a known star (or object).**
    - b) **Center the object in your eyepiece manually or with the N-S-E-W buttons.**
    - c) **Using *The Sky*, move your mouse cursor to the location of this object on the star map. Click on the star.** The "Object Information" dialog box will appear. Be sure the information matches the target object.
    - d) **Click on the Telescope tab.**
    - e) **Click on SYNC.**
  - 6) **At this point, the white crosshair circle on the screen will move to the object on which you have synced.** Continue using *The Sky*, as usual.
  - 7) **Parking the mount.** This feature can be used by all GTO mounts. However, if your chip is dated earlier than 11-13-00, the power to your mount must remain on between sessions. Keep in mind, we recommend that the power be disconnected so that you minimize the chance of damage due to lightening or power surges.
    - a) **Slew to the position that you want to designate as your park position.**
    - b) **Click Telescope | Options | Set Park Position to set that position.**
    - c) **When you have completed your observing session, select Telescope | Options | Park.** The telescope will slew to the position that you have established.

### **Functions available to all GTO control box versions**

- The Sky always places the Astro-Physics control system into the "long format" upon establishing a link.
- The Motion control window (click Telescope | Motion Control) allows four speed motion control (1x, 12x, 64x and 900x) by pressing and holding buttons down to adjust the telescope's position.
- Motion control window (Telescope | Motion Control) allows telescope to be "jogged" (a small telescope movement) a specified amount in any direction. Note, if you have a chip dated earlier than 11-13-00, the mount will go past the object and come back.
- Click Telescope | Options | Set Track Rates to specify a Sidereal, Solar, Lunar or Zero tracking rate (stops all tracking). The zero tracking rate requires a chip dated 11-13-00 or later.
- Click Telescope | Options | Focus Control to adjust a pulse focuser from *TheSky* (tested with JMI NGF Series focuser).
- Click Telescope | Options | Reticule to adjust the brightness of your reticle.



- Click Telescope | Options | Set Park Position to specify the "park position." The Sky will return the telescope to this position before parking the mount.
- The Sky queries the user if s/he wishes to park the telescope before terminating the link or exiting the software if the link is still active.
- Click Telescope | Options | Park to park the telescope. If you have a chip dated 11-13-00 or later, the park position will be remembered if you turn the power off. The park position will not be remembered if you have an earlier chip. In this instance, the white crosshair circle will point to the pole when you power up again.

### **Functions for mounts with chips dated 11-13-00 or later**

- Click Telescope | Options | Park to park the telescope. If you have a chip dated 11-13-00 or later, the park position will be remembered if you turn the power off.
- Setting the tracking rate to zero from The Sky (by clicking Telescope | Options | Set Track Rates).

### **Using the Keypad and The Sky Together**

You can switch back and forth between the keypad and *The Sky* as you wish. The mount will supply the RA and Dec position data to both continuously, so that they always know where they are pointing.

#### **If you slew with the keypad**

- Keypad displays - When you have arrived at the object, the object data screen will appear. If you return to the Objects Menu, you can press <PREV to see the data on the last object you selected. The NEXT> button will show you the current position.
- *The Sky* displays – The crosshair circle will move across the star map on your computer screen as your mount slews. Click on the object to see the Object Information.

#### **If you slew with *The Sky***

- *The Sky* displays – The crosshair circle will move across the star map on your computer screen as your mount slews. Click on the object to see the Object Information.
- Keypad displays – The current object screen display will not change to show data for the new object. However, if you go to the Objects Menu and press the NEXT> button, the correct current position will display.

#### **Using the Meridian Delay function with The Sky**

- Establish the link with *The Sky* and set the Meridian Delay on your keypad, as desired (please be sure to read the section regarding Meridian Delay carefully so that you fully understand how it works).
- Now the Meridian Delay function is active whether you slew with the keypad or *The Sky*.

#### **Using Guide rate (keypad) and Motion Controls (*The Sky*)**

- When you send a command to the mount using the motion controls of *The Sky*, you are sending the corresponding button rate to the mount. This is the same as if you were setting the button rate for the N-S-E-W buttons on the keypad.
- During a session, the servo drive (GTO control box) will be in whatever mode you left it in last, from whatever source you commanded. For instance, if you set the button rate on the keypad to 1x, then go to *The Sky* and issue a Move command (equivalent to 12x), the mount will remember the 12x even though your keypad says 1x. When you push the N-S-E-W buttons on the keypad, the mount will respond at the 12x that is in its memory. You will have to reselect 1x on your keypad to restore that rate to the N-S-E-W buttons.

#### **Safe Zone (keypad) and Telescope Limit Lines (*The Sky*)**

- If you are issuing slew commands using the keypad, the safe zone limits entered into the keypad will be honored.
- If you are slewing with *The Sky*, the Telescope Limit Lines will be used. These are two independent methods of determining where your telescope can point safely based on the parameters you set.

#### **Starting your session with the keypad plugged in**

- Use the External Startup Sequence and have your Keypad, Mount and Computer all synchronized in date, time and location. Please refer to the External Startup Sequence section of this manual.
- As an alternative you can start up the mount normally and connect to it with the sky. The use the Get Time/Location From Mount command found in the locations and time menu under the setup menu in the keypad. By doing this you will have your mount, keypad and computer all synchronized with the same clock, date and location.

# APPENDIX A: RS-232 COMMAND LANGUAGE - FIRMWARE VERSIONS C, KC, D OR KD

Text modified: 01-11-05

You can check the version of your chip by opening the cover of the GTO control box. If your chip is not dated at all, it was probably programmed prior to July 1999 and is an early version. The chip versions beginning with "K" are for the 400GTO and 600EGTO mounts shipped after 02-16-00.

In order to use the keypad software in this manual, you must have at least the C or KC version of the chip. The GTOCP1 and GTOCP2 control boxes can be upgraded to the D or KD chip versions. Please go the Technical Support section of the website for further information.

## C and KC commands

- a) Effective: 01-22-01
- b) KC include all commands listed below except command: :pS#

## D and KD commands

- c) Effective: 05-07-01
- d) All commands listed below.

## ***General Telescope Information:***

**Command:** :SG HH# or :SG HH:MM.M# or :SG HH:MM:SS#  
**Response:** "1"

Sets the offset from Greenwich mean time. Command may be issued in any format regardless of whether long format has been selected. Although any 24-hour format is acceptable, only the hours field is typically of interest.

**Command:** :Sg DDD\*MM# or :Sg DDD\*MM:SS#  
**Response:** "1"

Sets the current longitude. Command may be issued in long or short format regardless of whether long format has been selected.

**Command:** :St sDD\*MM# or :St sDD\*MM:SS  
**Response:** "1"

Sets the current latitude. Command may be issued in long or short format regardless of whether long format has been selected.

**Command:** :SL HH:MM:SS#  
**Response:** "1"

Sets the current local time. Command may be issued in long or short format regardless of whether long format has been selected.

**Command:** :SC MM/DD/YY#  
**Response:** 16 spaces followed by "#", followed by 16 spaces, followed by "#"

Sets the current date. Note that year fields equal to or larger than 97 are assumed to be 20<sup>th</sup> century, Year fields less than 97 are assumed to be 21<sup>st</sup> century.

**Command:** :GG#  
**Response:** HH:MM.M# or HH:MM:SS.S# if long format

Gets the offset from Greenwich mean time. Although typically only hours field is of interest, the return value will be in standard 24 hour format.

**Command:** :Gg#  
**Response:** +DDD\*MM# or +DDD\*MM:SS# if long format

Gets the current longitude.

**Command:** :Gt#  
**Response:** sDD\*MM# or sDD\*MM:SS# if long format

Gets the current latitude.

**Command:** :GL#  
**Response:** HH:MM.M# or HH:MM:SS.S# if long format  
Gets the current local time in 24 hr. format.

**Command:** :GS#  
**Response:** HH:MM.M# or HH:MM:SS.S# if long format

Gets the current sidereal time in 24 hr. format.

**Command:** :GR#  
**Response:** HH:MM.M# or HH:MM:SS.S# if long format

Gets the current Right Ascension.

**Command:** :GD#  
**Response:** sDD\*MM# or sDD\*MM:SS# if long format

Gets the current Declination.

**Command:** :GA#  
**Response:** sDD\*MM# or sDD\*MM:SS# if long format

Gets the current Altitude.

**Command:** :GZ#  
**Response:** sDD\*MM# or sDD\*MM:SS# if long format

Gets the current Azimuth.

## ***Telescope Motion***

**Command:** :Mn# :Ms# :Me# :Mw#  
**Response:** (none)

Command motion in the direction specified (n=north, s=south, e=east, w=west) at the currently selected guide or centering rate. Motion will continue until a quit command is issued.

**Command:** :NS#  
**Response:** (none)

This command swaps the functions of the north and south buttons. Subsequent commands :Mn# and :Ms# are affected.

**Command:** :EW#  
**Response:** (none)

This command swaps the functions of the east and west buttons. Subsequent commands :Me# and :Mw# are affected.

**Command:** :Qn# :Qs# :Qe# :Qw#  
**Response:** (none)

Stop motion in the specified axis. Note that :Qn# is identical to :Qs#, and :Qe# is identical to :Qw#. Motion is terminated only if it was not started by a slew (:MS#) command.

**Command:** :Q#  
**Response:** (none)

Motion in both axes is stopped, regardless of how the motion was invoked.

**Command:** :RG# :RG0# :RG1# :RG2#  
**Response:** (none)

Selects guide rate for the N-S-E-W buttons. Optionally selects 0.25x (:RG0#), 0.5x (:RG1#), or 1.0x (:RG2#). If no index is provided (:RG#), the previously selected guide rate will be used, else the power up default of 0.5x will be assumed by the motor drive.

**Command:** :RC# :RC0# :RC1# :RC2# :RC3#  
**Response:** (none)

Selects centering rate for the N-S-E-W buttons. Optionally selects a rate of 12x (:RC0#), 64x (:RC1#), 600x (:RC2#), or 1200x (:RC3#). If no index is provided (:RC#), then the previously selected speed will be used, else the power up default of 64x will be assumed by the motor drive.

**Command:** :RS# :RS0# :RS1# :RS2#  
**Response:** (none)

Selects the slew speed used by the telescope move functions. This command has no effect on the use of the N-S-E-W buttons (therefore, :RS# has no effect). The default slew speed is 1200x. Slewing can be done at 1200x (:RS2#), 900x (:RS1#), or 600x (:RS0#).

**Command:** :RT0# :RT1# :RT2# :RT9#  
**Response:** (none)

This command selects the tracking rate. It selects lunar (:RT0#), solar (:RT1#), sidereal (:RT2#), or zero (:RT9#). The sidereal rate is assumed as a default by the motor drive if nothing is specified. This command has no effect on the use of the N-S-E-W buttons. Zero tracking rate is useful in ALT-AZ mode.

**Command:** :Bd DD\*MM:SS# :Br DD\*MM:SS#  
**Response:** "1"

This command sets the amount of backlash compensation employed each time a servo motor axis reverses direction. Bd sets the backlash of the DEC axis, Br sets the backlash of the RA axis. Resolution of the backlash is in arc seconds. Typically, the degrees and minutes fields are zero to specify the amount of backlash only in

seconds. Values of backlash above 00\*54:36 may be truncated, depending upon which mount is used (this is a ridiculously large value, typical values should be well under 00\*01:00). The default DEC backlash is 00\*00:00, the default RA backlash is 00:00:15 (same as 00\*03:50). Backlash in either axis will be properly interpreted whether expressed as DD\*MM:SS or HH:MM:SS.

**Command:** :KA#  
**Response:** (none)

This command invokes the parked mode. The tracking stops and the motors are de-energized when slewing has completed. The mount will remain parked, even if power is cycled, until a move, quit, calibrate, or park-off command is issued. However, a power surge or glitch may cause the mount to start tracking once again.

**Command:** :PO#  
**Response:** (none)

Park-off. This command un-parks the mount and also restores calibration. To restore proper calibration, the mount must receive date and time (:SC dd/mm/yy# and :SL hh:mm:ss#) prior to receiving the Park-off command. If park-off is received when the mount is not actually parked, calibration error will be introduced. A :CM# command can be used, however, to establish accurate calibration.

**Command:** :pS#  
**Response:** "East#" or "West#"

This command returns the side of the pier on which the telescope is currently positioned. It is useful for remote observatories where it is not possible for the viewer to see the mount. Initially, the mount must be manually positioned on the proper pier side for the calibration object and calibrated using the :CM# command. The correct pier side will be returned after subsequent move, re-calibrate, park and unpark commands are completed.

**Command:** :p# :pR# :pP#  
**Response:** (none)

This command either invokes PEM record mode (:pR#), invokes PEM playback mode (:pP#), or turns playback off (:p#). The record function will remain active for one full revolution of the worm gear and cannot be terminated. If :p# or :pP# is received during record, it will be ignored. The time required for a record cycle depends upon which mount is used and how much correction is applied. Commands to slew will be ignored during record. Commands to select centering speed will become active only after the record cycle has been completed.

When playback is selected, it remains active until turned off. Playback is also temporarily turned off when a command to slew is issued or any of the N-S-E-W buttons are pressed. It is automatically reinvoked when the commanded position has been reached and none of the N-S-E-W buttons are pressed.

## Position

**Command:** :CM#  
**Response:** "Coordinates matched. #"  
(there are 5 spaces between "Coordinates" and "matched", and 8 trailing spaces before the "#", the total response length is 32 character plus the "#").

Calibrate mount. Current Right Ascension and Declination become the commanded Right Ascension and Declination respectively if in RA-DEC mode. If in ALT-AZ mode, then the commanded Altitude and Azimuth become the current. This command assumes that the mount has been manually positioned on the proper pier side for the calibration object. This command is ignored if slewing is in progress. This command should be used for initial calibration. It should not be used after the mount has been tracking unless it is known that it has not tracked across the meridian.

**Command:** :CMR#

**Response:** "Coordinates matched. #"

(there are 5 spaces between "Coordinates" and "matched", and 8 trailing spaces before the "#", the total

response length is 32 character plus the "#".

This command performs a function very similar to the :CM# command with one exception. It does not assume that the user has manually positioned the mount on the proper pier side for the object in view. It assumes that the pier side has not changed since the most recent :CM# or :MS# commands. It allows re-calibration on known coordinates even if the mount has tracked across the meridian. This command should not be used to perform the initial calibration. This command is ignored if slewing is in progress.

**Command:** :Sr HH:MM:SS# or :Sr HH:MM:SS.S#

**Response:** "1"

Defines the commanded Right Ascension, RA. Command may be issued in long or short format regardless of whether long format has been selected. RA specified as DD\*MM:SS will also be interpreted properly if greater precision is required, but this is not typically how RA is expressed. This command automatically selects RA-DEC mode. Move and calibrate commands operate on the most recently defined RA if in RA-DEC mode.

**Command:** :Sd sDD\*MM# or :Sd sDD\*MM:SS#

**Response:** "1"

Defines the commanded Declination, DEC. Command may be issued in long or short format regardless of whether long format has been selected. This command automatically selects RA-DEC mode. Move and calibrate commands operate on the most recently defined DEC if in RA-DEC mode.

**Command:** :Sa sDD\*MM# or :Sa sDD\*MM:SS#

**Response:** "1"

Defines the commanded Altitude, ALT. Command may be issued in long or short format regardless of whether long format has been selected. Move and calibrate commands operate on the most recently defined ALT. This command automatically selects ALT-AZ mode, however tracking rate is unaffected.

**Command:** :Sz DDD\*MM# or :Sz DDD\*MM:SS#

**Response:** "1"

Defines the commanded Azimuth, AZ. Command may be issued in long or short format regardless of whether long format has been selected. Move and calibrate commands operate on the most recently defined AZ. This command automatically selects ALT-AZ mode, however tracking rate is unaffected.

## **Miscellaneous**

**Command:** #

**Response:** (none)

Sending a # clears the input buffer. Advisable to do this before sending the very first command on power up.

**Command:** :U#

**Response:** (none)

Select long format, valid only for the communication port through which this command is issued, ports are controlled independently. Unlike the Meade definition, though, once long format has been selected it cannot be deselected without powering down the unit. Only the first occurrence of :U# acts upon the port in question. Long format only defines the format of the return strings, Input data (using the set command) will be recognized in any format whether or not long format has been selected.

**Command:** :B+# :B-#  
**Response:** (none)

Incrementally increases (B+) or decreases (B-) reticle brightness. Command to be sent over RS-232 each time a button is pressed to increase or decrease brightness. When the brightness is at the maximum, subsequent :B+# commands are ignored. When the brightness is at the minimum, subsequent :B-# commands are ignored. On power up, the brightness is at the minimum (off).

**Command:** :F+# :F-# :FF# :FS# :FQ#  
**Response:** (none)

Advances (F+) or retracts (F-) focus adjust motor on the eyepiece. F+ or F- commands commence adjustment and :FQ# stops it. This works the same way the N-S-E-W keypad works (it may even be an operating mode of the same keys). If :FS# has been issued previously, then the focus adjustment will be slow. If the :FF# command has been issued, then the adjustment will be fast. If neither FF nor FS is specified, the powerup default of FS is assumed.

**Command:** :de# :dn#  
**Response:** (none)

This command invokes the data feed through function between COM 1 and the keypad. The purpose is to allow software and database updates to the keypad, through the servo drive, without special connectors. For code downloads, :de# is used to provide transparent communications between COM 1 and the keypad with even parity. For database downloads, :dn# is used to provide transparent communications with no parity. Once either command is issued, normal operation (or parity change) can only be resumed by powering down the servo drive. COM 2 cannot be used in the transparent mode. Once the pound sign of the command has been received by the servo drive, all subsequent bytes received from COM 1 or the keypad are reflected to the other. Data received on COM 2 is ignored, and no data is transmitted from COM 2.

**Command:** :V#  
**Response:** (current servo controller software version number)

This command returns the current servo controller software version (followed by "#"). Software versions prior to B do not return anything since the version command is introduced in version B.

**Command:** :ho# :hq#  
**Response:** (none)

This command turns on (:ho#) and off (:hq#) the horizon check. The horizon check, when turned on, is performed when a "go-to" (or :MS#) is issued. If the coordinates define a location below zero degrees altitude, then the string "1Object is below horizon. #" is returned instead of "0". No compensation of coordinates for atmospheric refraction is made. On power-up, the horizon check is off since it is currently performed in the handheld controller, Digital Sky Voice, and Software Bisque's TheSky.

## ***Communicating with Your Mount When Writing Your Own Programs***

The command set is written in ASC11 character format and can be used to write your own programs. The commands are case sensitive. Nothing is sent to any ports unless you send a request per the AP protocol. You can use either serial port on your GTO Control Box.

In order to properly initialize the mount with your software, you must issue the following commands when you establish your link:

#	(clear the buffer)
:U#	(select long format)
:SL HH:MM:SS#	(set time)
:SC MM/DD/YY#	(set date)
:St sDD*MM# or :St sDD*MM:SS	(set latitude)

:Sg DDD\*MM# or :Sg DDD\*MM:SS# (set longitude)  
 :SG HH# or :SG HH:MM.M# or :SG HH:MM:SS# (set offset from Greenwich mean time, remember to calculate daylight savings, if needed)  
 :PO# (unpark mount)  
 :Q# (motion stop)

If you plan to poll the mount for its position while it is slewing, read this section. If the mount has a "D" "KD" or earlier chip installed, there is a possibility that an extraneous character might occur during a slew. This character will be a non-integer and will appear in the declination number in this manner where "A" represents a non-integer: -A33\*23:15# This character will not affect the accuracy of the slew in any way, it may simply affect your computer display of the mount position. We recommend that you write your program to ignore this character.

Please note that Astro-Physics does not support any programs that you write yourself or any program distributed as an after-market product. Please contact the manufacturer for questions relating to after-market programs.

### RS-232 Port Settings:

Baud Rate: 9600  
 Parity: none  
 Data bits: 8  
 Flow Control: none or Xon/Xoff  
 Start Bits: 1  
 Stop Bits: 1

### Command not functional

**Command:** :MS#  
**Response:** "0" if command accepted,  
 (none) if command not accepted,  
 "1Object is below horizon #"  
 if the horizon check is turned on, and the desired object is below 0 degrees altitude.  
 (8 trailing spaces before "#", 32 total characters plus "#")

Note: This command does not work properly in this version of the chip, however it did work in previous versions. Presently, the mount will slew to a new position even if it is below the horizon. Thereafter, it will indicate that a new set of coordinates is below the horizon regardless of what they actually are. The only way to get out of this mode is to either cycle power or use the N-S-E-W buttons to move to a position above the horizon.

The keypad, DigitalSky Voice software and TheSky software all have their own internal horizon check routines, which function properly. This problem only occurs in other software developed for the PC and written with this specific command to poll the chip.

Target command: Slew to the most recently defined RA and DEC coordinates in RA-DEC mode, or most recently define ALT and AZ coordinates in ALT-AZ mode. Slewing is performed at the currently selected slew rate. If the horizon check is turned on, and the object is below the horizon, this will be stated, and no slewing will occur.



# APPENDIX B: RS-232 COMMAND LANGUAGE - FIRMWARE VERSION G

Commands effective: 06-30-04  
Text modified: 01-11-05

These are the commands associated with version G of the ROM chip in the GTOCP3 Control Box. You can check the version of your chip by opening the cover of the control box. If your GTOCP3 Control Box has a chip designated as G with a date prior to 6-30-04 or F, contact Astro-Physics for a replacement.

## ***General Telescope Information:***

**Command:** :sSG HH# or :sSG HH:MM.M# or :sSG HH:MM:SS#  
**Response:** "1"

Sets the offset from Greenwich mean time. Command may be issued in any format regardless of whether long format has been selected. Although any 24-hour format is acceptable, only the hours field is typically of interest. Data entered with this command will be "remembered" through a power cycle and automatically re-applied on the next powerup.

**Command:** :Sg DDD\*MM# or :Sg DDD\*MM:SS#  
**Response:** "1"

Sets the current longitude. Command may be issued in long or short format regardless of whether long format has been selected. Data entered with this command will be "remembered" through a power cycle and automatically re-applied on the next powerup.

**Command:** :St sDD\*MM# or :St sDD\*MM:SS  
**Response:** "1"

Sets the current latitude. Command may be issued in long or short format regardless of whether long format has been selected. Data entered with this command will be "remembered" through a power cycle and automatically re-applied on the next powerup.

**Command:** :SL HH:MM:SS#  
**Response:** "1"

Sets the current local time. Command may be issued in long or short format regardless of whether long format has been selected.

**Command:** :SC MM/DD/YY#  
**Response:** 32 spaces followed by "#", followed by 32 spaces, followed by "#"

Sets the current date. Note that year fields equal to or larger than 97 are assumed to be 20<sup>th</sup> century, Year fields less than 97 are assumed to be 21<sup>st</sup> century.

**Command:** :GG#  
**Response:** West Longitude HH:MM.M# or HH:MM:SS.S# if long format  
East Longitude Refer to the chart below in the section entitled "Communicating with your Mount when writing your own program".

Gets the offset from Greenwich mean time. Although typically only hours field is of interest, the return value will be in standard 24 hour format.

**Command:** :Gg#  
**Response:** +DDD\*MM# or +DDD\*MM:SS# if long format

Gets the current longitude.

**Command:** :Gt#  
**Response:** sDD\*MM# or sDDD\*MM# if short format  
or sDD\*MM:SS# or sDDD\*MM:SS if long format

Gets the current latitude.

**Command:** :GL#  
**Response:** HH:MM.M# or HH:MM:SS.S# if long format

Gets the current local time in 24 hr. format. Overflows from 23:59:59 to 00:00:00. Updates calendar day on overflow.

**Command:** :GS#  
**Response:** HH:MM.M# or HH:MM:SS.S# if long format

Gets the current sidereal time in 24 hr. format.

**Command:** :GR#  
**Response:** HH:MM.M# or HH:MM:SS.S# if long format

Gets the current Right Ascension.

**Command:** :GD#  
**Response:** sDD\*MM# or sDD\*MM:SS# if long format

Gets the current Declination.

**Command:** :GA#  
**Response:** sDD\*MM# or sDD\*MM:SS# if long format

Gets the current Altitude.

**Command:** :GZ#  
**Response:** sDD\*MM# or sDD\*MM:SS# if long format

Gets the current Azimuth.

**Command:** :GC#  
**Response:** MM:DD:YY#  
Gets the current calendar day. Leading zero appears only in the year field.

## ***Telescope Motion***

**Command:** :MS#  
**Response:** "0" if command accepted,  
(none) if command not accepted,  
"1Object is below horizon #"  
if the horizon check is turned on, and the desired object is below 0 degrees altitude.  
(8 trailing spaces before "#", 32 total characters plus "#")

Target command: Slew to the most recently defined RA and DEC coordinates in RA-DEC mode, or most recently define ALT and AZ coordinates in ALT-AZ mode. Slewing is performed at the currently selected slew rate. If the horizon check is turned on, and the object is below the horizon, this will be stated, and no slewing will occur.

Note that the keypad, DigitalSky Voice software and TheSky software all have their own internal horizon check routines.

**Command:** :Mn# :Ms# :Me# :Mw#  
**Response:** (none)

Command motion in the direction specified (n=north, s=south, e=east, w=west) at the currently selected guide or centering rate. Motion will continue until a quit command is issued.

**Command:** :Mnxxx# :Msxxx# :Mexxx# :Mwxxx#  
**Response:** (none)

Command motion for xxx milliseconds in the direction specified at the currently selected guide rate. If xxx has a value of zero, motion is continuous and requires a quit command to terminate. Otherwise a quit command will not terminate.

**Command:** :NS#  
**Response:** (none)

This command swaps the functions of the north and south buttons. Subsequent commands :Mn# and :Ms# are affected.

**Command:** :EW#  
**Response:** (none)

This command swaps the functions of the east and west buttons. Subsequent commands :Me# and :Mw# are affected.

**Command:** :Qn# :Qs# :Qe# :Qw#  
**Response:** (none)

Stop motion in the specified axis. Note that :Qn# is identical to :Qs#, and :Qe# is identical to :Qw#. Motion is terminated only if it was not started by a slew (:MS#) command.

**Command:** :Q#  
**Response:** (none)

Motion in both axes is stopped, regardless of how the motion was invoked.

**Command:** :RG# :RG0# :RG1# :RG2#  
**Response:** (none)

Selects guide rate for the N-S-E-W buttons. Optionally selects 0.25x (:RG0#), 0.5x (:RG1#), or 1.0x (:RG2#). If no index is provided (:RG#), the previously selected guide rate will be used, else the power up default of 0.5x will be assumed by the motor drive.

**Command:** :RC# :RC0# :RC1# :RC2# :RC3#  
**Response:** (none)

Selects centering rate for the N-S-E-W buttons. Optionally selects a rate of 12x (:RC0#), 64x (:RC1#), 600x (:RC2#), or 1200x (:RC3#). If no index is provided (:RC#), then the previously selected speed will be used, else the power up default of 64x will be assumed by the motor drive. These rates are predefined selections for the command :RCxxx# as shown below.

**Command:** :Rcxxx#  
**Response:** (none)

Sets the centering rate for the N-S-E-W buttons to xxx. Xxx is an integer from 1 to 255.

**Command:** :RS# :RS0# :RS1# :RS2#  
**Response:** (none)

Selects the slew speed used by the telescope move functions. This command has no effect on the use of the N-S-E-W buttons (therefore, :RS# has no effect). The default slew speed is 1200x. Slewing can be done at 1200x (:RS2#), 900x (:RS1#), or 600x (:RS0#).

**Command:** :RT0# :RT1# :RT2# :RT9#  
**Response:** (none)

This command selects the tracking rate. It selects lunar (:RT0#), solar (:RT1#), sidereal (:RT2#), or zero (:RT9#). The sidereal rate is assumed as a default by the motor drive if nothing is specified. This command has no effect on the use of the N-S-E-W buttons. Zero tracking rate is useful in ALT-AZ mode. These rates are predefined selections for the command :RR sxxx.xxx# as shown below.

**Command:** :RR sxxx.xxx# :RD sxxx.xxx#  
**Response:** "1"

This command selects the tracking rate in the RA axis ("RR") or DEC axis ("RD") to xxx.xxx. The rate added to the standard sidereal rate and can be positive or negative.

**Command:** :Bd DD\*MM:SS# :Br DD\*MM:SS#  
**Response:** "1"

This command sets the amount of backlash compensation employed each time a servo motor axis reverses direction. Bd sets the backlash of the DEC axis, Br sets the backlash of the RA axis. Resolution of the backlash is in arc seconds. Typically, the degrees and minutes fields are zero to specify the amount of backlash only in seconds. Values of backlash above 00\*54:36 may be truncated, depending upon which mount is used (this is a ridiculously large value, typical values should be well under 00\*01:00). The default DEC backlash is 00\*00:00, the default RA backlash is 00:00:15 (same as 00\*03:50). Backlash in either axis will be properly interpreted whether expressed as DD\*MM:SS or HH:MM:SS.

**Command:** :KA#  
**Response:** (none)

This command invokes the parked mode. The tracking stops and the motors are de-energized when slewing has completed. The mount will remain parked, even if power is cycled, until a move, quit, calibrate, or park-off command is issued. However, a power surge or glitch may cause the mount to start tracking once again.

**Command:** :PO#  
**Response:** (none)

Park-off. This command un-parks the mount and also restores calibration. To restore proper calibration, the mount must receive date and time (:SC dd/mm/yy# and :SL hh:mm:ss#) prior to receiving the Park-off command. If park-off is received when the mount is not actually parked, calibration error will be introduced. A :CM# command can be used, however, to establish accurate calibration.

**Command:** :pS#  
**Response:** "East#" or "West#"

This command returns the side of the pier on which the telescope is currently positioned. It is useful for remote observatories where it is not possible for the viewer to see the mount. Initially, the mount must be manually

positioned on the proper pier side for the calibration object and calibrated using the :CM# command. The correct pier side will be returned after subsequent move, re-calibrate, park and unpark commands are completed.

**Command:** :p# :pR# :pP#  
**Response:** (none)

This command either invokes PEM record mode (:pR#), invokes PEM playback mode (:pP#), or turns playback off (:p#). The record function will remain active for one full revolution of the worm gear and cannot be terminated. If :p# or :pP# is received during record, it will be ignored. The time required for a record cycle depends upon which mount is used and how much correction is applied. Commands to slew will be ignored during record. Commands to select centering speed will become active only after the record cycle has been completed.

When playback is selected, it remains active until turned off. Playback is also temporarily turned off when a command to slew is issued or any of the N-S-E-W buttons are pressed. It is automatically reinvoked when the commanded position has been reached and none of the N-S-E-W buttons are pressed.

**Command:** :FM#  
**Response:** (none)

Equatorial Fork: This command is the manufacturing default, which eliminates the meridian flip.

German Equatorial: This command is intended for software developers. It turns off the meridian flip and makes a German Equatorial mount behave like a fork mount. It is not to be used by individuals without slewing safeguards. It is mainly intended as a tool for writers of mount control software to implement slewing past the meridian during imaging, and then only with the proper limits and controls to prevent the telescope from slewing into the pier or other abnormal motions. It overrides the manufacturing default. The manufacturing default (meridian flip) is restored after a power cycle.

**Command:** :EM#  
**Response:** (none)

Equatorial Fork: This command is intended for software developers. If used with a fork mount, it overrides the manufacturing default and invokes a meridian flip. The manufacturing default (no meridian flip) is restored after a power cycle.

German Equatorial: This command is the manufacturing default, which invokes the meridian. If :FM# had been used to eliminate the meridian flip, this command restores the mount back to a normal equatorial mount.

## Position

**Command:** :CM#  
**Response:** "Coordinates matched. #"  
(there are 5 spaces between "Coordinates" and "matched", and 8 trailing spaces before the "#", the total response length is 32 character plus the "#").

Calibrate mount. Current Right Ascension and Declination become the commanded Right Ascension and Declination respectively if in RA-DEC mode. If in ALT-AZ mode, then the commanded Altitude and Azimuth become the current. This command assumes that the mount has been manually positioned on the proper pier side for the calibration object. This command is ignored if slewing is in progress. This command should be used for initial calibration. It should not be used after the mount has been tracking unless it is known that it has not tracked across the meridian.

**Command:** :CMR#

**Response:** "Coordinates matched. #"

(there are 5 spaces between "Coordinates" and "matched", and 8 trailing spaces before the "#", the total

response length is 32 character plus the "#".

This command performs a function very similar to the :CM# command with one exception. It does not assume that the user has manually positioned the mount on the proper pier side for the object in view. It assumes that the pier side has not changed since the most recent :CM# or :MS# commands. It allows re-calibration on known coordinates even if the mount has tracked across the meridian. This command should not be used to perform the initial calibration. This command is ignored if slewing is in progress.

**Command:** :Sr HH:MM:SS# or :Sr HH:MM:SS.S#

**Response:** "1"

Defines the commanded Right Ascension, RA. Command may be issued in long or short format regardless of whether long format has been selected. RA specified as DD\*MM:SS will also be interpreted properly if greater precision is required, but this is not typically how RA is expressed. This command automatically selects RA-DEC mode. Move and calibrate commands operate on the most recently defined RA if in RA-DEC mode.

**Command:** :Sd sDD\*MM# or :Sd sDD\*MM:SS#

**Response:** "1"

Defines the commanded Declination, DEC. Command may be issued in long or short format regardless of whether long format has been selected. This command automatically selects RA-DEC mode. Move and calibrate commands operate on the most recently defined DEC if in RA-DEC mode.

**Command:** :Sa sDD\*MM# or :Sa sDD\*MM:SS#

**Response:** "1"

Defines the commanded Altitude, ALT. Command may be issued in long or short format regardless of whether long format has been selected. Move and calibrate commands operate on the most recently defined ALT. This command automatically selects ALT-AZ mode, however tracking rate is unaffected.

**Command:** :Sz DDD\*MM# or :Sz DDD\*MM:SS#

**Response:** "1"

Defines the commanded Azimuth, AZ. Command may be issued in long or short format regardless of whether long format has been selected. Move and calibrate commands operate on the most recently defined AZ. This command automatically selects ALT-AZ mode, however tracking rate is unaffected.

## **Miscellaneous**

**Command:** #

**Response:** (none)

Sending a # clears the input buffer. Advisable to do this before sending the very first command on power up.

**Command:** :U#

**Response:** (none)

Select long format, valid only for the communication port through which this command is issued, ports are controlled independently. Unlike the Meade definition, though, once long format has been selected it cannot be deselected without powering down the unit. Only the first occurrence of :U# acts upon the port in question. Long format only defines the format of the return strings, Input data (using the set command) will be recognized in any format whether or not long format has been selected.

**Command:** :B+# :B-#

**Response:** (none)

Incrementally increases (B+) or decreases (B-) reticle brightness. Command to be sent over RS-232 each time a button is pressed to increase or decrease brightness. When the brightness is at the maximum, subsequent :B+# commands are ignored. When the brightness is at the minimum, subsequent :B-# commands are ignored. On power up, the brightness is at the minimum (off).

**Command:** :F+# :F-# :FF# :FS# :FQ#

**Response:** (none)

Advances (F+) or retracts (F-) focus adjust motor on the eyepiece. F+ or F- commands commence adjustment and :FQ# stops it. This works the same way the N-S-E-W keypad works (it may even be an operating mode of the same keys). If :FS# has been issued previously, then the focus adjustment will be slow. If the :FF# command has been issued, then the adjustment will be fast. If neither FF nor FS is specified, the powerup default of FS is assumed.

**Command:** :de# :dn#

**Response:** (none)

This command invokes the data feed through function between COM 1 and the keypad. The purpose is to allow software and database updates to the keypad, through the servo drive, without special connectors. For code downloads, :de# is used to provide transparent communications between COM 1 and the keypad with even parity. For database downloads, :dn# is used to provide transparent communications with no parity. Once either command is issued, normal operation (or parity change) can only be resumed by powering down the servo drive. COM 2 cannot be used in the transparent mode. Once the pound sign of the command has been received by the servo drive, all subsequent bytes received from COM 1 or the keypad are reflected to the other. Data received on COM 2 is ignored, and no data is transmitted from COM 2.

**Command:** :V#

**Response:** (current servo controller software version number)

This command returns the current servo controller software version (followed by "#"). Software versions prior to B do not return anything since the version command is introduced in version B.

**Command:** :ho# :hq#

**Response:** (none)

This command turns on (:ho#) and off (:hq#) the horizon check. The horizon check, when turned on, is performed when a "go-to" (or :MS#) is issued. If the coordinates define a location below zero degrees altitude, then the string "1Object is below horizon. #" is returned instead of "0". No compensation of coordinates for atmospheric refraction is made. On power-up, the horizon check is off since it is currently performed in the handheld controller, Digital Sky Voice, and Software Bisque's TheSky.

## ***Communicating with Your Mount When Writing Your Own Programs***

The command set is written in ASC11 character format and can be used to write your own programs. The commands are case sensitive. Nothing is sent to any ports unless you send a request per the AP protocol. You can use either serial port on your GTO Control Box.

In order to properly initialize the mount with your software, you must issue the following commands when you establish your link:

```
#          (to clear the buffer)
:U#
:SL HH:MM:SS#
:SC MM/DD/YY#
```

:St sDD\*MM# or :St sDD\*MM:SS (if not done in a previous session, command remembered through power cycle)  
 :Sg DDD\*MM# or :Sg DDD\*MM:SS# (if not done in a previous session, command remembered through power cycle)  
 :SG HH# or :SG HH:MM.M# or :SG HH:MM:SS# (remember to calculate daylight savings, if needed) (if not done in a previous session, command remembered through power cycle)  
 :PO#  
 :Q#

If you plan to poll the mount for its position while it is slewing, read this section. If the mount has a "D" "KD" or earlier chip installed, there is a possibility that an extraneous character might occur during a slew. This character will be a non-integer and will appear in the declination number in this manner where "A" represents a non-integer: -A33\*23:15# This character will not affect the accuracy of the slew in any way, it may simply affect your computer display of the mount position. We recommend that you write your program to ignore this character.

Considerations for E longitude locations. Negative offsets sent to the mount will be interpreted correctly. If you plan to use the :GG# command to read the offset from the mount, you will need to allow for the return values as shown in the chart below. The values shown do not have any numerical significance, but represent the corresponding time zones.

Time Zone	Return value for offset of GMT
-01	:A5:MM.M# or :A5:MM:SS.S#
-02	:A4:MM.M# or :A4:MM:SS.S#
-03	:A3:MM.M# or :A3:MM:SS.S#
-04	:A2:MM.M# or :A2:MM:SS.S#
-05	:A1:MM.M# or :A1:MM:SS.S#
-06	:00:MM.M# or :00:MM:SS.S#
-07	:@9:MM.M# or :@9:MM:SS.S#
-08	:@8:MM.M# or :@8:MM:SS.S#
-09	:@7:MM.M# or :@7:MM:SS.S#
-10	:@6:MM.M# or :@6:MM:SS.S#
-11	:@5:MM.M# or :@5:MM:SS.S#
-12	:@4:MM.M# or :@4:MM:SS.S#

Please note that Astro-Physics does not support any programs that you write yourself or any program distributed as an after-market product. Please contact the manufacturer for questions relating to after-market programs.

### RS-232 Port Settings:

Baud Rate: 9600  
 Parity: none  
 Data bits: 8  
 Flow Control: none or Xon/Xoff  
 Start Bits: 1  
 Stop Bits: 1



# APPENDIX C: COMMON STARS – BY CONSTELLATION

Constellation	Star Name	Flamsteed-Bayer Designation	Abbrev	Magnitude(SAO)
<b>Andromeda</b>				
	Alpheratz	21-Alpha Andromedae	Alf And	2.1
	Mirach	43-Beta Andromedae	Bet And	2.4
	Almach	57-Gamma1 Andromedae	Gam And	2.3
<b>Aquarius</b>				
	Sadalmelik	34-Alpha Aquarii	Alf Aqr	3.2
	Sadalsuud	22-Beta Aquarii	Bet Aqr	3.1
	Skat	76-Delta Aquarii	Del Aqr	3.5
	Albali	2-Epsilon Aquarii	Eps Aqr	3.8
<b>Aquila</b>				
	Altair	53-Alpha Aquilae	Alf Aql	0.9
	Alshain	60-Beta Aquilae	Bet Aql	3.9
	Tarazed	50-Gamma Aquilae	Gam Aql	2.8
<b>Aries</b>				
	Hamal	13-Alpha Arietis	Alf Ari	2.2
	Sheratan	6-Beta Arietis	Bet Ari	2.7
	Mesarthim	5-Gamma2 Arietis	Gam Ari	4.8
<b>Auriga</b>				
	Capella	Alpha Aurigae	Alf Aur	0.1
	Menkalinan	34-Beta Aurigae	Bet Aur	2.1
<b>Boötes</b>				
	Arcturus	16-Alpha Boötis	Alf Boo	0.2
	Nekkar	42-Beta Boötis	Bet Boo	3.6
	Seginus	27-Gamma Boötis	Gam Boo	3.0
	Izar	36-Epsilon Boötis	Eps Boo	2.7
	Muphrid	8-Eta Boötis	Eta Boo	2.8
	Alkalurops	51-Mu1 Boötis	Mu Boo	4.5
<b>Cancer</b>				
	Acubens	65-Alpha Cancri	Alf Cnc	4.3
	Asellus Borealis	43-Gamma Cancri	Gam Cnc	4.7
	Asellus Australis	47-Delta Cancri	Del Cnc	4.2
<b>Canis Major</b>				
	Sirius	9-Alpha Canis Majoris	Alf CMa	-1.6
	Mirzam	2-Beta Canis Majoris	Bet CMa	2.0
	Wezen	25-Delta Canis Majoris	Del CMa	2.0

	Adhara	21-Epsilon Canis Majoris	Eps CMa	1.6
	Furud	1-Zeta Canis Majoris	Zet CMa	3.1
	Aludra	31-Eta Canis Majoris	Eta CMa	2.4
<b>Canis Minor</b>				
	Procyon	10-Alpha Canis Minoris	Alf CMi	0.5
	Gomeisa	3-Beta Canis Minoris	Bet CMi	3.1
<b>Canis Venatici</b>				
	Cor Caroli	12-Alpha Canum Venaticorum	Alf CVn	2.9
	Chara	8-Beta Canum Venaticorum	Bet CVn	4.3
<b>Capricornus</b>				
	Algedi	6-Alpha2 Capricorni	Alf Cap	3.8
	Dabih	9-Beta1 Capricorni	Bet Cap	3.3
	Nashira	40-Gamma Capricorni	Gam Cap	3.8
	Deneb Algedi	49-Delta Capricorni	Del Cap	3.0
<b>Carina</b>				
	Canopus	Alpha Carinae	Alf Car	-0.9
	Miaplacidus	Beta Carinae	Bet Car	1.8
	Avior	Epsilon Carinae	Eps Car	1.7
	Aspidiske	Iota Carinae	Iot Car	2.3
<b>Cassiopeia</b>				
	Schedar	18-Alpha Cassiopeiae	Alf Cas	2.5
	Caph	Beta Cassiopeia	Bet Cas	2.3
	Navi	27-Gamma Cassiopeiae	Gam Cas	2.8
	Ruchbah	37-Delta Cassiopeiae	Del Cas	2.7
<b>Centaurus</b>				
	Alpha Centauri	Alpha1 Centauri	Alf Cen	0.1
	Hadar	Beta Centauri	Bet Cen	0.9
	Menkent	5-Theta Centauri	Tet Cen	2.3
<b>Cepheus</b>				
	Alderamin	5-Alpha Cephei	Alf Cep	2.6
	Alfirk	8-Beta Cephei	Bet Cep	3.3
	Erral	35-Gamma Cephei	Gam Cep	3.4
	Kurhah	17-Xi Cephei	Xi Cep	4.6
<b>Cetus</b>				
	Menkar	92-Alpha Ceti	Alf Cet	2.8
	Diphda	16-Beta Ceti	Bet Cet	2.2
	Kaffaljdhma	86-Gamma Ceti	Gam Cet	3.6
	Baten Kaitos	55-Zeta Ceti	Zet Cet	3.9
	Mira	Omicron Ceti	Omi Cet	2.1

**Columba**

Phact	Alpha Columbae	Alf Col	2.8
Wazn	Beta Columbae	Bet Col	3.2

**Corona Borealis**

Alphecca	5-Alpha Coronae Borealis	Alf CrB	2.3
Nusakan	3-Beta Coronae Borealis	Bet CrB	3.7

**Corvus**

Alchiba	1-Alpha Corvi	Alf Crv	4.2
Gienah	4-Gamma Corvi	Gam Crv	2.8
Algorab	7-Delta Corvi	Del Crv	3.1

**Crater**

Alkes	7-Alpha Crateris	Alf Crt	4.2
-------	------------------	---------	-----

**Crux**

Acrux	Alpha2 Crucis	Alf Cru	1.6
Mimosa	Beta Crucis	Bet Cru	1.5
Gacrux	Gamma Crucis	Gam Cru	1.6

**Cygnus**

Deneb	50-Alpha Cygni	Alf Cyg	1.3
Albireo	6-Beta1 Cygni	Bet Cyg	3.2
Sadr	37-Gamma Cygni	Gam Cyg	2.3

**Draco**

Thuban	11-Alpha Draconis	Alf Dra	3.6
Rastaban	23-Beta Draconis	Bet Dra	3.0
Eltanin	33-Gamma Draconis	Gam Dra	2.4
Altair	57-Delta Draconis	Del Dra	3.2
Edasich	12-Iota Draconis	Iot Dra	3.5
Giasar	1-Lambda Draconis	Lam Dra	4.1
Alrakis	21-Mu Draconis	Mu Dra	5.1
Grumium	32-Xi Draconis	Xi Dra	3.9

**Equuleus**

Kitelpha	8-Alpha Equulei	Alf Equ	4.1
----------	-----------------	---------	-----

**Eridanus**

Achernar	Alpha Eridani	Alf Eri	0.6
Cursa	67-Beta Eridani	Bet Eri	2.9
Zaurak	34-Gamma Eridani	Gam Eri	3.2
Azha	3-Eta Eridani	Eta Eri	4.0
Acamar	Theta Eridani	Tet Eri	3.2
Beid	38-Omicron Eridani	Omi Eri	4.1
Keid	40-Omicron2 Eridani	Omi Eri	4.5

**Gemini**

Castor	66-Alpha Geminorum	Alf Gem	1.6
Pollux	78-Beta Geminorum	Bet Gem	1.2
Alhena	24-Gamma Geminorum	Gam Gem	1.9
Wasat	55-Delta Geminorum	Del Gem	3.5
Mebstata	27-Epsilon Geminorum	Eps Gem	3.2
Mekbuda	43-Zeta Geminorum	Zet Gem	3.9
Propus	Eta Geminorum	Eta Gem	3.3

**Grus**

AlNair	Alpha Gruis	Alf Gru	2.2
--------	-------------	---------	-----

**Hercules**

Rasalgethi	64-Alpha Herculis	Alf Her	3.5
Kornephoros	27-Beta Herculis	Bet Her	2.8

**Hydra**

Alphard	30-Alpha Hydrae	Alf Hya	2.2
---------	-----------------	---------	-----

**Leo**

Regulus	32-Alpha Leonis	Alf Leo	1.3
Denebola	94-Beta Leonis	Bet Leo	2.2
Algieba	41-Gamma2 Leonis	Gam Leo	2.6
Zosma	68-Delta Leonis	Del Leo	2.6
Adhafera	36-Zeta Leonis	Zet Leo	3.6
Alterf	4-Lambda Leonis	Lam Leo	4.5
Chertan	70-Theta Leonis	Tet Leo	3.4
Rasalas	24-Mu Leonis	Mu Leo	4.1
Arneb	11-Alpha Leporis	Alf Lep	2.7
Nihal	9-Beta Leporis	Bet Lep	3.0

**Libra**

Zubenelgenubi	9-Alpha2 Librae	Alf Lib	2.9
Zubeneschamali	27-Beta Librae	Bet Lib	2.7

**Lyra**

Vega	3-Alpha Lyrae	Alf Lyr	0.1
Sheliak	10-Beta Lyrae	Bet Lyr	3.9
Sulafat	14-Gamma Lyrae	Gam Lyr	3.3

**Ophiuchus**

Rasalhague	55-Alpha Ophiuchi	Alf Oph	2.1
Cebalrai	60-Beta Ophiuchi	Bet Oph	2.9
Yed Prior	1-Delta Ophiuchi	Del Oph	3.0
Yed Posterior	2-Epsilon Ophiuchi	Eps Oph	3.3
Sabik	35-Eta Ophiuchi	Eta Oph	2.6
Marfik	10-Lambda Ophiuchi	Lam Oph	3.9

**Orion**

Betelgeuse	58-Alpha Orionis	Alf Ori	0.6
Rigel	19-Beta Orionis	Bet Ori	0.3
Bellatrix	24-Gamma Orionis	Gam Ori	1.7
Alnilam	46-Epsilon Orionis	Eps Ori	1.8
Mintaka	34-Delta Orionis	Del Ori	2.5
Alnitak	50-Zeta Orionis	Zet Ori	2.0
Trapezium	41-Theta1 Orionis	Tet Ori	5.4
Saiph	53-Kappa Orionis	Kap Ori	2.2
Meissa	39-Lambda Orionis	Lam Ori	3.7

**Pavo**

Peacock	Alpha Pavonis	Alf Pav	2.1
---------	---------------	---------	-----

**Pegasus**

Markab	54-Alpha Pegasi	Alf Peg	2.6
Scheat	53-Beta Pegasi	Bet Peg	2.6
Algenib	88-Gamma Pegasi	Gam Peg	2.9
Enif	8-Epsilon Pegasi	Eps Peg	2.5
Homam	42-Zeta Pegasi	Zet Peg	3.6
Matar	44-Eta Pegasi	Eta Peg	3.1
Biham	26-Theta Pegasi	Tet Peg	3.7

**Perseus**

Mirfak	33-Alpha Persei	Alf Per	1.9
Algol	26-Beta Persei	Bet Per	2.9
Atik	44-Zeta Persei	Zet Per	2.9
Menkib	46-Xi Persei	Xi Per	4.0

**Phoenix**

Ankaa	Alpha Phoenicis	Alf Phe	2.4
-------	-----------------	---------	-----

**Pisces**

Alrescha	113-Alpha Piscium	Alf Psc	4.3
----------	-------------------	---------	-----

**Piscis Austrinus**

Fomalhaut	24-Alpha Piscis Austrini	Alf PsA	1.3
-----------	--------------------------	---------	-----

**Sagittarius**

Rukbat	Alpha Sagittarii	Alf Sgr	4.1
Arkab	Beta1 Sagittarii	Bet Sgr	4.3
Alnasi	10-Gamma2 Sagittarii	Gam Sgr	3.1
Kaus Media	19-Delta Sagittarii	Del Sgr	2.8
Kaus Australis	20-Epsilon Sagittarii	Eps Sgr	2.0
Ascella	38-Zeta Sagittarii	Zet Sgr	2.7
Kaus Borealis	22-Lambda Sagittarii	Lam Sgr	2.9
Nunki	34-Sigma Sagittarii	Sig Sgr	2.1

**Scorpius**

Antares	21-Alpha Scorpii	Alf Sco	1.1
Graffias	8-Beta Scorpii	Bet Sco	2.9
Shaula	35-Lambda Scorpii	Lam Sco	1.7
Lesath	34-Upsilon Scorpii	Ups Sco	2.8

**Serpens**

Unukalhai	24-Alpha Serpentis	Alf Ser	2.8
Alya	63-Theta Serpentis	Tet Ser	4.5

**Taurus**

Aldebaran	87-Alpha Tauri	Alf Tau	1.1
Elnath	112-Beta Tauri	Bet Tau	1.8
Alcyone	25-Eta Tauri	Eta Tau	3.0
Celaeno	16 Tauri	16 Tau	5.4
Electra	17 Tauri	17 Tau	3.8
Taygeta	19 Tauri	19 Tau	4.4
Maia	20 Tauri	20 Tau	3.9
Sterope	21 Tauri	21 Tau	5.9
Merope	23 Tauri	23 Tau	4.3
Atlas	27 Tauri	27 Tau	3.8
Pleione	28 Tauri	28 Tau	5.2

**Triangulum Australe**

Atria	Alpha Trianguli Australis	Alf TrA	1.9
-------	---------------------------	---------	-----

**Ursa Major**

Dubhe	50-Alpha Ursae Majoris	Alf UMa	2.0
Merak	48-Beta Ursae Majoris	Bet UMa	2.4
Phecda	64-Gamma Ursae Majoris	Gam UMa	2.5
Alioth	77-Delta Ursae Majoris	Eps UMa	1.7
Megrez	69-Delta Ursae Majoris	Del UMa	3.4
Mizar	79-Zeta Ursae Majoris	Zet UMa	2.4
Alkaid	85-Eta Ursae Majoris	Eta UMa	1.9
Talitha	9-Iota Ursae Majoris	Iot UMa	3.0
Tania Borealis	33-Lambda Ursae Majoris	Lam UMa	3.5
Tania Australis	34-Mu Ursae Majoris	Mu UMa	3.2
Alula Borealis	54-Nu Ursae Majoris	Nu UMa	3.7
Alula Australis	53-Xi Ursae Majoris	Xi UMa	3.9
Muscida	1-Omicron Ursae Majoris	Omi UMa	3.5
Alcor	80 Ursae Majoris	80 UMa	4.0

**Ursa Minor**

Polaris	1-Alpha Ursae Minoris	Alf UMi	2.1
Kochab	7-Beta Ursae Minoris	Bet UMi	2.2

<b>Vela</b>	Pherkad	13-Gamma Ursae Minoris	Gam UMi	3.1
	Regor	Gamma2 Velorum	Gam Vel	1.9
	Suhail	Lambda Velorum	Lam Vel	2.2
<b>Virgo</b>				
	Spica	67-Alpha Virginis	Alf Vir	1.2
	Zavijava	5-Beta Virginis	Bet Vir	3.8
	Porrina	29-Gamma Virginis	Gam Vir	2.9
	Vindematrix	47-Epsilon Virginis	Eps Vir	3.0
	Zaniah	15-Eta Virginis	Eta Vir	4.0
	Syrma	99-Iota Virginis	lot Vir	4.2

## APPENDIX D: ALPHABETICAL STAR LIST

These stars are listed in the same order as they appear on your display when you are either following the calibration routine or have chosen Stars from the Objects Menu . Note that Polaris appears twice.

<b>Common Name</b>	<b>Flamsteed-Bayer Designation</b>	<b>Abbrev.</b>	<b>Magnitude (SAO)</b>
Polaris	Alpha Ursae Minoris	Alf UMi	2.1
Acamar	Theta Eridani	Tet Eri	3.2
Achernar	Alpha Eridani	Alf Eri	0.6
Acrux	Alpha2 Crucis	Alf Cru	1.6
Acubens	65-Alpha Cancri	Alf Cnc	4.3
Adhafera	36-Zeta Leonis	Zet Leo	3.6
Adhara	21-Epsilon Canis Majoris	Eps CMa	1.6
Albali	2-Epsilon Aquarii	Eps Aqr	3.8
Albireo	6-Beta1 Cygni	Bet Cyg	3.2
Alchiba	1-Alpha Corvi	Alf Crv	4.2
Alcor	80 Ursae Majoris	80 UMa	4.0
Alcyone	25-Eta Tauri	Eta Tau	3.0
Aldebaran	87-Alpha Tauri	Alf Tau	1.1
Alderamin	5-Alpha Cephei	Alf Cep	2.6
Alfirk	8-Beta Cephei	Bet Cep	3.3
Algedi	6-Alpha2 Capricorni	Alf Cap	3.8
Algenib	88-Gamma Pegasi	Gam Peg	2.9
Algieba	41-Gamma2 Leonis	Gam Leo	2.6
Algol	26-Beta Persei	Bet Per	2.9
Algorab	7-Delta Corvi	Del Crv	3.1
Alhena	24-Gamma Geminorum	Gam Gem	1.9
Alioth	77-Epsilon Ursae Majoris	Eps UMa	1.7
Alkaid	85-Eta Ursae Majoris	Eta UMa	1.9
Alkalurops	51-Mu1 Boötis	Mu Boo	4.5
Alkes	7-Alpha Crateris	Alf Crt	4.2
Almach	57-Gamma1 Andromedae	Gam And	2.3
AlNair	Alpha Gruis	Alf Gru	2.2
Alnasl	10-Gamma2 Sagittarii	Gam Sgr	3.1
Alnilam	46-Epsilon Orionis	Eps Ori	1.8
Alnitak	50-Zeta Orionis	Zet Ori	2.0
Alpha Centauri	Alpha1 Centauri	Alf Cen	0.1
Alphard	30-Alpha Hydrae	Alf Hya	2.2
Alphecca	5-Alpha Coronae Borealis	Alf CrB	2.3
Alpheratz	21-Alpha Andromedae	Alf And	2.1
Alrakis	21-Mu Draconis	Mu Dra	5.1



Alrescha	113-Alpha Piscium	Alf Psc	4.3
Alshain	60-Beta Aquilae	Bet Aql	3.9
Altair	53-Alpha Aquilae	Alf Aql	0.9
Altais	57-Delta Draconis	Del Dra	3.2
Alterf	4-Lambda Leonis	Lam Leo	4.5
Aludra	31-Eta Canis Majoris	Eta CMa	2.4
Alula Australis	53-Xi Ursae Majoris	Xi UMa	3.9
Alula Borealis	54-Nu Ursae Majoris	Nu UMa	3.7
Alya	63-Theta Serpentis	Tet Ser	4.5
Ankaa	Alpha Phoenicis	Alf Phe	2.4
Antares	21-Alpha Scorpii	Alf Sco	1.1
Arcturus	16-Alpha Boötis	Alf Boo	0.2
Arkab	Beta1 Sagittarii	Bet Sgr	4.3
Arneb	11-Alpha Leporis	Alf Lep	2.7
Ascella	38-Zeta Sagittarii	Zet Sgr	2.7
Asellus Australis	47-Delta Cancri	Del Cnc	4.2
Asellus Borealis	43-Gamma Cancri	Gam Cnc	4.7
Aspidiske	Iota Carinae	lot Car	2.3
Atik	44-Zeta Persei	Zet Per	2.9
Atlas	27 Tauri	27 Tau	3.8
Atria	Alpha Trianguli Australis	Alf TrA	1.9
Avior	Epsilon Carinae	Eps Car	1.7
Azha	3-Eta Eridani	Eta Eri	4.0
Baten Kaitos	55-Zeta Ceti	Zet Cet	3.9
Beid	38-Omicron Eridani	Omi Eri	4.1
Bellatrix	24-Gamma Orionis	Gam Ori	1.7
Betelgeuse	58-Alpha Orionis	Alf Ori	0.6
Biham	26-Theta Pegasi	Tet Peg	3.7
Canopus	Alpha Carinae	Alf Car	-0.9
Capella	Alpha Aurigae	Alf Aur	0.1
Caph	Beta Cassiopeiae	Bet Cas	2.3
Castor	66-Alpha Germinorum	Alf Gem	1.6
Cebalrai	60-Beta Ophiuchi	Bet Oph	2.9
Celaeno	16 Tauri	16 Tau	5.4
Chara	8-Beta Canum Venaticorum	Bet CVn	4.3
Chertan	70-Theta Leonis	Tet Leo	3.4
Cor Caroli	12-Alpha2 Canum Venaticorum	Alf CVn	2.9
Cursa	67-Beta Eridani	Bet Eri	2.9
Dabih	9-Beta1 Capricorni	Bet Cap	3.3

Deneb	50-Alpha Cygni	Alf Cyg	1.3
Deneb Algedi	49-Delta Capricorni	Del Cap	3.0
Denebola	94-Beta Leonis	Bet Leo	2.2
Diphda	16-Beta Ceti	Bet Cet	2.2
Double Double			6.0
Dubhe	50-Alpha Ursae Majoris	Alf UMa	2.0
Edasich	12-Iota Draconis	lot Dra	3.5
Electra	17 Tauri	17 Tau	3.8
Elnath	112-Beta Tauri	Bet Tau	1.8
Eltanin	33-Gamma Draconis	Gam Dra	2.4
Enif	8-Epsilon Pegasi	Eps Peg	2.5
Errai	35-Gamma Cephei	Gam Cep	3.4
Fomalhaut	24-Alpha Piscis Austrini	Alf PsA	1.3
Furud	1-Zeta Canis Majoris	Zet CMa	3.1
Gacrux	Gamma Crucis	Gam Cru	1.6
Giasar	1-Lambda Draconis	Lam Dra	4.1
Gienah	4-Gamma Corvi	Gam Crv	2.8
Gomeisa	3-Beta Canis Minoris	Bet CMi	3.1
Graffias	8-Beta Scorpii	Bet Sco	2.9
Grumium	32-Xi Draconis	Xi Dra	3.9
Hadar	Beta Centauri	Bet Cen	0.9
Hamal	13-Alpha Arietis	Alf Ari	2.2
Hinds Crimson Star			6.0
Homam	42-Zeta Pegasi	Zet Peg	3.6
Izar	36-Epsilon Boötis	Eps Boo	2.7
Kaffaljdhma	86-Gamma Ceti	Gam Cet	3.6
Kaus Australis	20-Epsilon Sagittarii	Eps Sgr	2.0
Kaus Borealis	22-Lambda Sagittarii	Lam Sgr	2.9
Kaus Media	19-Delta Sagittarii	Del Sgr	2.8
Keid	40-Omicron2 Eridani	Omi Eri	4.5
Kitalpha	8-Alpha Equulei	Alf Equ	4.1
Kochab	7-Beta Ursae Minoris	Bet UMi	2.2
Kornephoros	27-Beta Herculis	Bet Her	2.8
Kurhah	17-Xi Cephei	Xi Cep	4.6
Lesath	34-Upsilon Scorpii	Ups Sco	2.8
Maia	20 Tauri	20 Tau	3.9
Marfik	10-Lambda Ophiuchi	Lam Oph	3.9
Markab	54-Alpha Pegasi	Alf Peg	2.6
Matar	44-Eta Pegasi	Eta Peg	3.1

Mebsuta	27-Epsilon Geminorum	Eps Gem	3.2
Megrez	69-Delta Ursae Majoris	Del UMa	3.4
Meissa	39-Lambda Orionis	Lam Ori	3.7
Mekbuda	43-Zeta Geminorum	Zet Gem	3.9
Menkalinan	34-Beta Aurigae	Bet Aur	2.1
Menkar	92-Alpha Ceti	Alf Cet	2.8
Menkent	5-Theta Centauri	Tet Cen	2.3
Menkib	46-Xi Persei	Xi Per	4.0
Merak	48-Beta Ursae Majoris	Bet UMa	2.4
Merope	23 Tauri	23 Tau	4.3
Mesarthim	5-Gamma1 Arietis	Gam Ari	4.8
Miaplacidus	Beta Carinae	Bet Car	1.8
Mimosa	Beta Crucis	Bet Cru	1.5
Mintaka	34-Delta Orionis	Del Ori	2.5
Mira	Omicron Ceti	Omi Cet	2.1
Mirach	43-Beta Andromedae	Bet And	2.4
Mirfak	33-Alpha Persei	Alf Per	1.9
Mirzam	2-Beta Canis Majoris	Bet CMa	2.0
Mizar	79-Zeta Ursae Majoris	Zet UMa	2.4
Muphrid	8-Eta Boötis	Eta Boo	2.8
Muscida	1-Omicron Ursae Majoris	Omi UMa	3.5
Nashira	40-Gamma Capricorni	Gam Cap	3.8
Navi	27-Gamma Cassiopeiae	Gam Cas	2.8
Nekkar	42-Beta Boötis	Bet Boo	3.6
Nihal	9-Beta Leporis	Bet Lep	3.0
Nunki	34-Sigma Sagittarii	Sig Sgr	2.1
Nusakan	3-Beta Coronae Borealis	Bet CrB	3.7
Peacock	Alpha Pavonis	Alf Pav	2.1
Phact	Alpha Columbae	Alf Col	2.8
Phecda	64-Gamma Ursae Majoris	Gam UMa	2.5
Pherkad	13-Gamma Ursae Minoris	Gam UMi	3.1
Pleione	28 Tauri	28 Tau	5.2
Polaris	1-Alpha Ursae Minoris	Alf UMi	2.1
Pollux	78-Beta Geminorum	Bet Gem	1.2
Porrima	29-Gamma Virginis	Gam Vir	2.9
Procyon	10-Alpha Canis Minoris	Alf CMi	0.5
Propus	Eta Geminorum	Eta Gem	3.3
Rasalas	24-Mu Leonis	Mu Leo	4.1
Rasalgethi	64-Alpha Herculis	Alf Her	3.5

Rasalhague	55-Alpha Ophiuchi	Alf Oph	2.1
Rastaban	23-Beta Draconis	Bet Dra	3.0
Regor	Gamma2 Velorum	Gam Vel	1.9
Regulus	32-Alpha Leonis	Alf Leo	1.3
Rigel	19-Beta Orionis	Bet Ori	0.3
Ruchbah	37-Delta Cassiopeiae	Del Cas	2.7
Rukbat	Alpha Sagittarii	Alf Sgr	4.1
Sabik	35-Eta Ophiuchi	Eta Oph	2.6
Sadalmelik	34-Alpha Aquarii	Alf Aqr	3.2
Sadalsuud	22-Beta Aquarii	Bet Aqr	3.1
Sadr	37-Gamma Cygni	Gam Cyg	2.3
Saiph	53-Kappa Orionis	Kap Ori	2.2
Scheat	53-Beta Pegasi	Bet Peg	2.6
Schedar	18-Alpha Cassiopeiae	Alf Cas	2.5
Seginus	27-Gamma Boötis	Gam Boo	3.0
Shaula	35-Lambda Scorpii	Lam Sco	1.7
Sheliak	10-Beta Lyrae	Bet Lyr	3.9
Sheratan	6-Beta Arietis	Bet Ari	2.7
Sirius	9-Alpha Canis Majoris	Alf CMa	-1.6
Skat	76-Delta Aquarii	Del Aqr	3.5
Spica	67-Alpha Virginis	Alf Vir	1.2
Sterope	21 Tauri	21 Tau	5.9
Suhail	Lambda Velorum	Lam Vel	2.2
Sulafat	14-Gamma Lyrae	Gam Lyr	3.3
Syrma	99-Iota Virginis	Iot Vir	4.2
Talitha	9-Iota Ursae Majoris	Iot UMa	3.1
Tania Australis	34-Mu Ursae Majoris	Mu UMa	3.2
Tania Borealis	33-Lambda Ursae Majoris	Lam UMa	3.5
Tarazed	50-Gamma Aquilae	Gam Aql	2.8
Taygeta	19 Tauri	19 Tau	4.4
Thuban	11-Alpha Draconis	Alf Dra	3.6
Trapezium	41-Theta1 Orionis	Tet Ori	5.4
Unukalhai	24-Alpha Serpentis	Alf Ser	2.8
UU	none	none	5.1
Vega	3-Alpha Lyrae	Alf Lyr	0.1
Vindemiatrix	47-Epsilon Virginis	Eps Vir	3.0
Wasat	55-Delta Geminorum	Del Gem	3.5
Wazn	Beta Columbae	Bet Col	3.2
Wezen	25-Delta Canis Majoris	Del CMa	2.0

Yed Posterior	2-Epsilon Ophiuchi	Eps Oph	3.3
Yed Prior	1-Delta Ophiuchi	Del Oph	3.0
Zaniah	15-Eta Virginis	Eta Vir	4.0
Zaurak	34-Gamma Eridani	Gam Eri	3.2
Zavijava	5-Beta Virginis	Bet Vir	3.8
Zosma	68-Delta Leonis	Del Leo	2.6
Zubenelgenubi	9-Alpha2 Librae	Alf Lib	2.9
Zubeneschamali	27-Beta Librae	Bet Lib	2.7
Sun			
Moon			
Venus			
Mars			
Jupiter			

## APPENDIX E: CONSTELLATION ABBREVIATIONS

And	Andromeda	Lac	Lacerta
Ant	Antlia	Leo	Leo
Aps	Apus	LMi	Leo Minor
Aqr	Aquarius	Lep	Lepus
Aql	Aquila	Lib	Libra
Ara	Ara	Lup	Lupus
Ari	Aries	Lyn	Lynx
Aur	Auriga	Lyr	Lyra
Boo	Boötes	Men	Mensa
Cae	Caelum	Mic	Microscopium
Cam	Camelopardalis	Mon	Monoceros
Cnc	Cancer	Mus	Musca
CVn	Canes Venatici	Nor	Norma
CMa	Canis Major	Oct	Octans
CMi	Canis Minor	Oph	Ophiuchus
Cap	Capricornus	Ori	Orion
Car	Carina	Pav	Pavo
Cas	Cassiopeia	Peg	Pegasus
Cen	Centaurus	Per	Perseus
Cep	Cepheus	Phe	Phoenix
Cet	Cetus	Pic	Pictor
Cha	Chamaeleon	Psc	Pisces
Cir	Circinus	PsA	Piscis Austrinus
Col	Columba	Pup	Puppis
Com	Coma Berenices	Pyx	Pyxis
CrA	Corona Australis	Ret	Reticulum
CrB	Corona Borealis	Sge	Sagitta
Crv	Corvus	Sgr	Sagittarius
Crt	Crater	Sco	Scorpius
Cru	Crux	Sci	Sculptor
Cyg	Cygnus	Sct	Scutum
Del	Delphinus	Ser	Serpens
Dor	Dorado	Sex	Sextans
Dra	Draco	Tau	Taurus
Equ	Equuleus	Tel	Telescopium
Eri	Eridanus	Tri	Triangulum
For	Fornax	TrA	Triangulum Australe
Gem	Gemini	Tuc	Tucana
Gru	Grus	UMa	Ursa Major
Her	Hercules	UMi	Ursa Minor
Hor	Horologium	Vel	Vela
Hya	Hydra	Vir	Virgo
Hyi	Hydrus	Vol	Volans
Ind	Indus	Vul	Vulpecula

## APPENDIX F: COMMON OBJECT NAMES

These objects are listed in the order in which they appear on the screen.

47Tuc	Filamentary Nebula	Praesepe
Andromeda Galaxy	Flaming Star Nebula	Ring Nebula in Lyra
Antennae	Ghost of Jupiter	Rosette Nebula
Barnard's Galaxy	Great Cluster in Hercules	Saturn Nebula
Baxendell's Nebula	Great Nebula in Andromeda	Sculptor Galaxy
Bear Paw Galaxy	Great Nebula in Orion	Siamese Twins
Beehive Cluster	Helix Galaxy	Sombrero Galaxy
Black-eye Galaxy	Helix Nebula	Southern Pleiades
Blinking Planetary	Hind's Variable Nebula	Spindle Galaxy
Blue Snowball	Horsehead Nebula	Star Queen Nebula
Blue Planetary	Hourglass Nebula	Stephan's Quintet
Bode's Nebula	Hubble's Variable Nebula	Struve's Lost Nebula
Box	Jewel Box	Sunflower Galaxy
Box Nebula	Lacework Nebula	Tarantula Nebula
Bubble Nebula	Lagoon Nebula	Toby Jug Nebula
Bug Nebula	Little Dumbell	Triangulum Galaxy
Butterfly Cluster	Little Gem	Trifid Nebula
Butterfly Nebula	Maia Nebula	Veil Nebula
California Nebula	Merope Nebula	Whirlpool Galaxy
Christmas Tree Cluster	The Mice	Wild Duck Cluster
Cocoon Nebula	Network-1 Nebula	Witch Head Nebula
Cone Nebula	Network-2 Nebula	Eta Carina Nebula
Copeland's Septet	North American Nebula	Gamma Cas Nebula
Crab Nebula	Omega Nebula	Gamma Cygnus Nebula
Crescent Nebula	Owl Nebula	Kappa Cru Cluster
Double Cluster	Papillon	Lambda-1 Cen Nebula
Dumbell Nebula	Pelican Nebula	Lambda-2 Cen Nebula
Eagle Nebula	Pin-wheel Nebula	Omega Cen
Eight-burst Planetary	Polarissima Australis	Rho Oph Nebula
Eskimo Nebula	Polarissima Borealis	
The Eyes		

# APPENDIX G: AITKEN'S DOUBLE STAR (ADS) LIST

These commonly observed double stars were chosen from R. G. Aitken's New General Catalog of Double Stars. Please note that the separations are approximate and may vary from year to year. If you are an avid double star observer, please consult an ephemeris for the most accurate data.

ADS Number	Name	ADS Separation	Number	Name	Separation
00111	Kappa1 Sci	1.4	02257	Epsilon Ari	1.4
00191	35 Psc	11.6	02312	Rho2 Eri	1.8
00434	Lambda Cas	0.6	02362	Beta Per	81.0
00513	Pi And	35.9	02402	Alpha For	5.1
00520	Beta 395 Cet	0.5	02616	7 Tau	0.8
00558	55 Psc	6.5	02799	Omicron Sigma 65 Tau	0.2
00624	HN 122	36.1	02843	Zeta Per	12.9
00671	Eta Cas	12.9	02867	Omicron Sigma 67 Cam	12.9
00683	65 Psc	4.4	02888	Epsilon Per	8.8
00755	36 And	0.9	03079	39 Eri	6.4
00782	Gamma Cas	2.1	03093	Omicron2 Eri	83.4
00899	Psi1 Psc	30.0	03137	Phi Tau	52.1
00996	Zeta Psc	23.0	03161	Chi Tau	19.4
01003	37 Cet	49.7	03321	Alpha Tau	121.7
01081	42 Cet	1.6	03572	Omega Aur	5.4
01129	Psi Cas	25.0	03797	Rho Ori	7.0
01394	Epsilon Scl	4.7	03800	Kappa Lep	2.6
01457	1 Air	2.8	03823	Beta Ori	9.5
01477	Alpha UMi	18.4	04002	Eta Ori	1.5
01507	Gamma Ari	7.8	04066	Beta Lep	2.5
01538	Sigma 186 Cet	1.1	04134	Delta Ori	52.6
01563	Lambda Ari	37.4	04177	19 Cam	1.3
01598	48 Cas	0.9	04179	Lambda Ori	4.4
01615	Alpha Psc	1.8	04186	Theta1 Ori	
01630	Gamma And	9.8	04241	Sigma Ori	0.2
01631	10 Ari	1.1	04263	Zeta Ori	2.3
01683	59 And	16.6	04334	Gamma Lep	96.3
01697	6 Tri	3.9	04566	Theta Aur	3.6
01703	66 Cet	16.5	04773	41 Aur	7.7
01778	Omicron Cet	0.1	04841	Eta Gem	1.6
01860	Iota Cas	2.5	04990	Mu Gem	121.7
01954	Omega For	10.8	05012	Epsilon Mon	13.4
02080	Gamma Cet	2.8	05107	Beta Mon	7.3
02157	Eta Per	28.3	05166	20 Gem	20.0
02200	20 Per	14.1	05253	Nu1 CMa	17.5



05400	12 Lyn	1.7	08572	Delta Crv	24.2
05423	Alpha CMa	4.6	08573	Beta 28 Crv	2.2
05514	14 Lyn	0.4	08600	24 Com	20.3
05559	38 Gem	5.2	08630	Gamma Vir	1.8
05605	Mu CMa	3.0	08682	Sigma 1694 Cam	21.6
05654	Epsilon CMa	7.5	08695	35 Com	1.2
05961	Lambda Gem	9.6	08706	Alpha CVn	19.4
05983	Delta Gem	5.8	08801	Theta Vir	7.1
06101	Eta CMi	4.0	08891	Zeta UMa	14.4
06175	Alpha Gem	3.9	08974	25 CVn	1.8
06190	n Pup	9.6	09000	84 Vir	2.9
06255	k Pup	9.9	09025	Tau Boo	4.8
06321	Kappa Gem	7.1	09085	Tau Vir	80.0
06420	9 Pup	0.2	09173	Kappa Boo	13.4
06650	Zeta Cnc	6.0	09198	Iota Boo	38.5
06724	Sigma 1193 UMa	43.1	09273	Phi Vir	4.8
06815	Phi2 Cnc	5.1	09338	Pi Boo	5.6
06914	Beta 208 Pyx	1.6	09343	Zeta Boo	0.8
06988	Iota Cnc	30.5	09372	Epsilon Boo	2.8
06993	Epsilon Hya	2.7	09396	Mu Lib	1.8
07114	Iota UMa	2.0	09406	39 Boo	2.9
07203	Sigma2 UMa	3.9	09413	Xi Boo	6.6
07292	38 Lyn	2.7	09425	Omicron Sigma 288 Boo	0.8
07307	Sigma 1338 Lyn	1.0	09494	44,i Boo	2.2
07351	Kappa Leo	2.1	09532	Iota1 Lib	57.8
07390	Omega Leo	0.6	09584	5 Ser	11.2
07402	23 UMa	22.7	09617	Eta CrB	0.8
07545	Phi UMa	0.3	09626	Mu Boo	108.3
07555	Gamma Sex	0.6	09701	Delta Ser	4.4
07654	Alpha Leo	176.9	09737	Zeta CrB	6.3
07724	Gamma Leo	4.4	09909	Xi Sco	0.4
07846	Beta 411 Hya	1.4	09913	Beta Sco	13.6
08119	Xi UMa	1.8	09951	Nu Sco	41.1
08123	Nu UMa	7.2	09979	Alpha CrB	7.1
08148	Iota Leo	1.7	10049	Rho Oph	3.1
08153	Gamma Crt	5.2	10058	Eta Dra	5.2
08175	57 UMa	5.4	10074	Alpha Sco	2.6
08196	88 Leo	8.4	10087	Lambda Oph	1.5
08197	Omicron Sigma 235 UMa	0.6	10157	Zeta Her	0.8
08406	2 Com	3.7	10279	20 Dra	1.3
08539	Sigma 1639 Com	1.7	10345	Mu Dra	1.9

10418	Alpha Her	4.6	15536	Eta PsA	1.7
10424	Delta Her	8.9	15600	Xi Cep	8.2
10526	Rho Her	4.1	15719	Sigma 2883 Cep	14.6
10628	Nu Dra	61.9	15753	41 Aqr	5.0
10660	26 Dra	1.7	15764	Sigma 2893 Cep	28.9
10759	Psi1 Dra	30.3	15828	Sigma 2894 Lac	15.6
10786	Mu Her	33.8	15934	53 Aqr	3.1
10875	90 Her	1.6	15971	Zeta Aqr	2.1
11005	Tau Oph	1.7	15987	Delta Cep	41.0
11046	70 Oph	4.5	16095	8 Lac	22.4
11061	40/41 Dra	19.3	16261	Xi Peg	11.5
11483	Omicron Sigma 358 Her	1.3	16268	Tau1 Aqr	23.7
11635	Epsilon Lyr	207.7	16538	Pi Cep	1.1
11639	Zeta Lyr	43.7	16633	Psi1 Aqr	49.6
11745	Beta Lyr	45.7	16666	Omicron Cep	2.8
11853	Theta Ser	22.3	16672	94 Aqr	12.7
12197	Eta Lyr	28.1	16836	72 Peg	0.5
12540	Beta Cyg	34.4	16957	78 Peg	1.0
12789	Sigma 2573 Dra	18.2	16979	107 Aqr	6.6
12880	Delta Cyg	2.5	17022	6 Cas	1.6
12962	Pi Aql	1.4	17140	Sigma Cas	3.0
13007	Epsilon Dra	3.1	17175	85 Peg	0.7
13148	Psi Cyg	3.2			
13371	Sigma 2640 Dra	5.6			
2	Theta Sge	11.9			
13524	Kappa Cep	7.4			
13632	Alpha1 Cap	45.4			
13645	Alpha2 Cap	6.6			
13765	Gamma Cyg	41.2			
13887	Rho Cap	0.5			
14158	49 Cyg	2.7			
14259	52 Cyg	6.0			
14279	Gamma Del	9.6			
14296	Lambda Cyg	0.9			
14360	4 Aqr	0.8			
14499	Epsilon Equ	0.8			
14636	61 Cyg	30.3			
14787	Tau Cyg	0.8			
15032	Beta Cep	13.3			
15270	Mu Cyg	1.2			
15281	Kappa Peg	0.2			

## APPENDIX H: THE GREEK ALPHABET

We have included this list for your reference to help you translate Greek letter designations that may be used in your star atlas or other reference. The abbreviations are used in Stars/Constell Tour as described on page 32 and in

### Symbol Translation Abbreviation

A	α	Alpha	Alf
B	β	Beta	Bet
Γ	γ	Gamma	Gam
Δ	δ	Delta	Del
E	ε	Epsilon	Eps
Z	ζ	Zeta	Zet
H	η	Eta	Eta
Θ	θ	Theta	Tet
I	ι	Iota	Iot
K	κ	Kappa	Kap
Λ	λ	Lambda	Lam
M	μ	Mu	Mu
N	ν	Nu	Nu
Ξ	ξ	Xi	Xi
O	ο	Omicron	Omi
Π	π	Pi	Pi
P	ρ	Rho	Rho
Σ	σ	Sigma	Sig
T	τ	Tau	Tau
Υ	υ	Upsilon	Ups
Φ	φ	Phi	Phi
X	χ	Chi	Chi
Ψ	ψ	Psi	Psi
Ω	ω	Omega	Ome

# APPENDIX I: MENU LAYOUT

We have included this menu layout for your reference to help you learn the menu system. This part of the manual has not been completely updated for version 4.12. You may find errors, but it should be helpful overall.

## Keypad Version 4.0 Screens and Map

### Startup to Main Menu

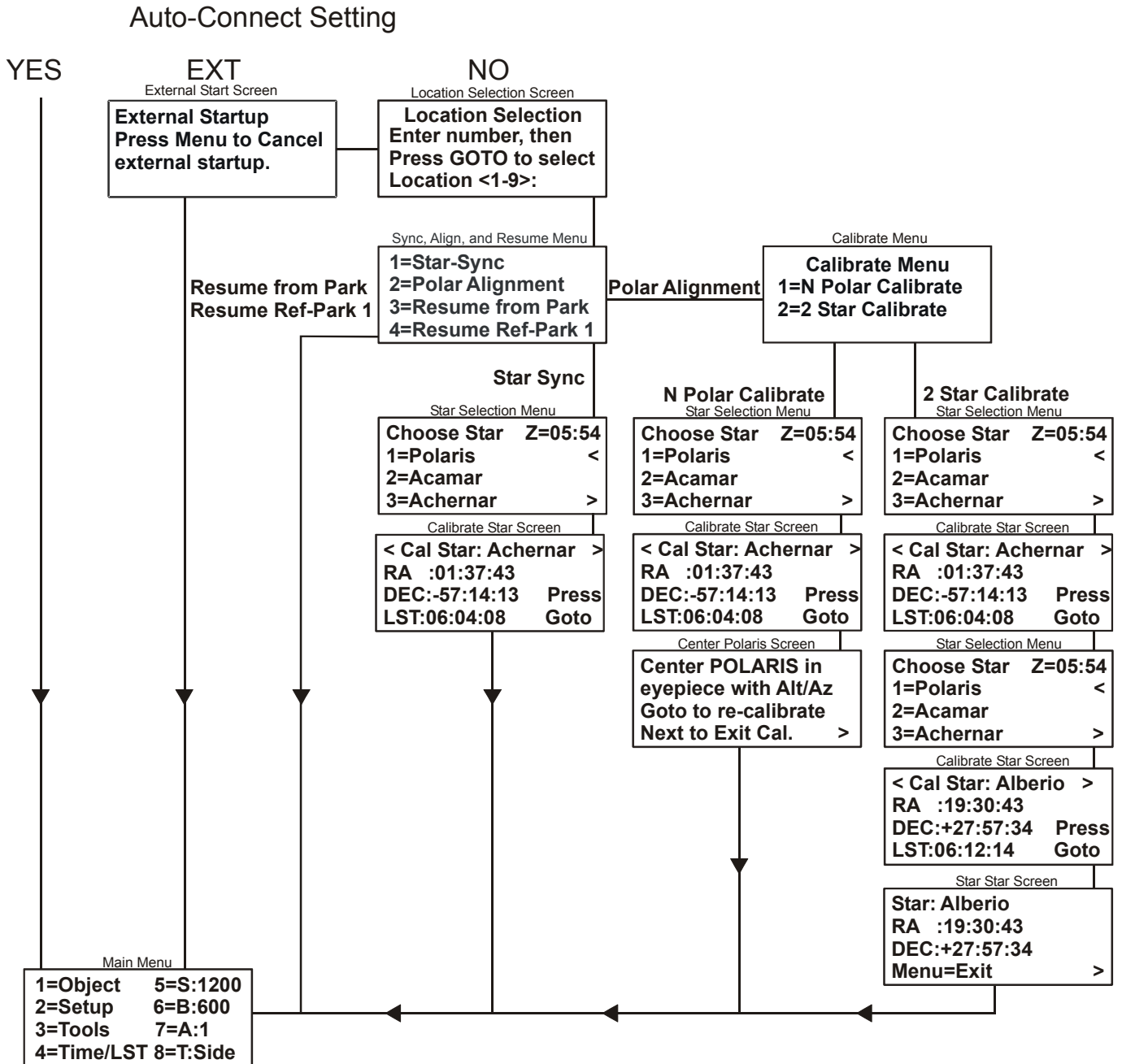

# Keypad Version 4.0 Screens and Map

## Main Menu to Sub Menus

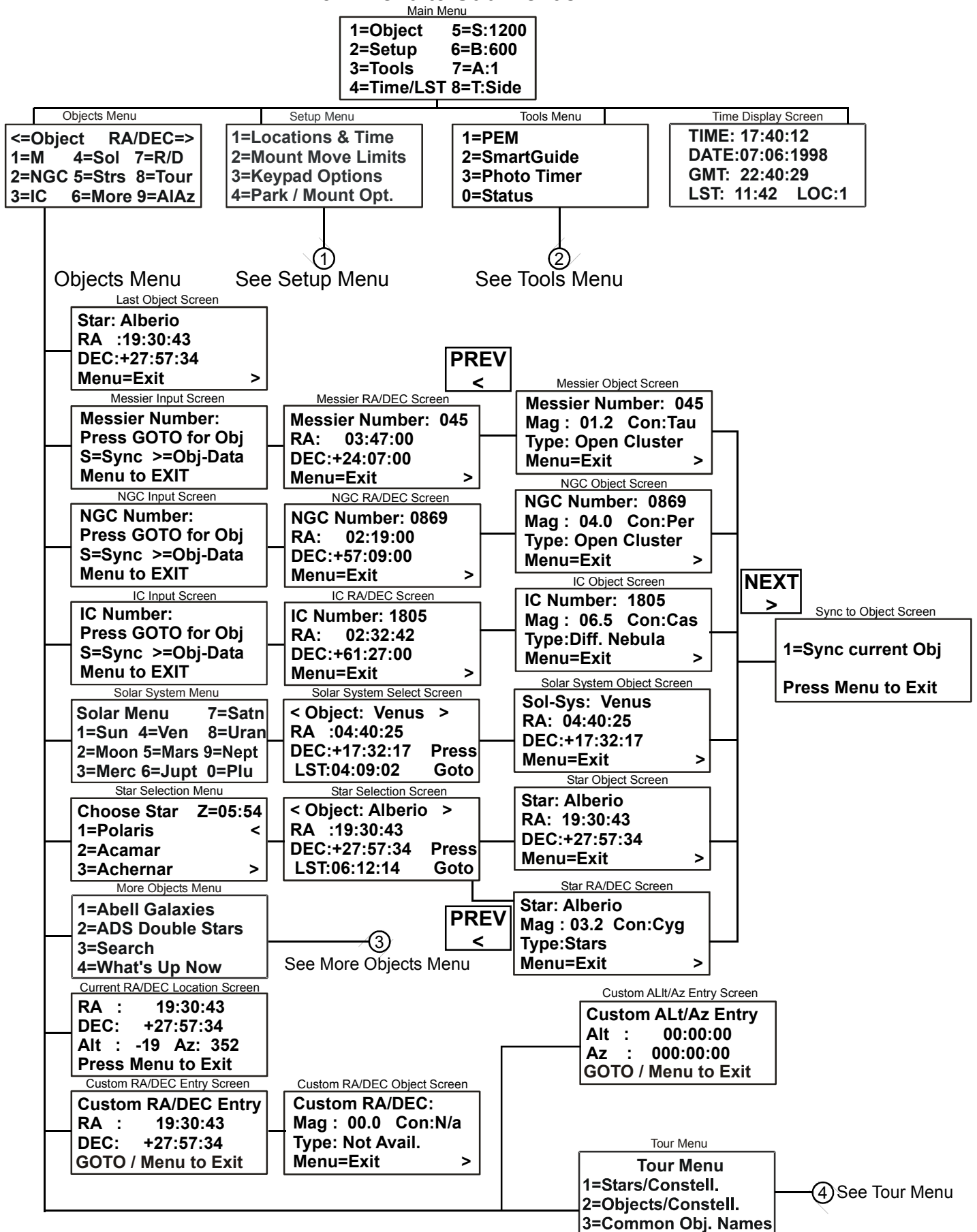

# Keypad Version 4.0 Screens and Map

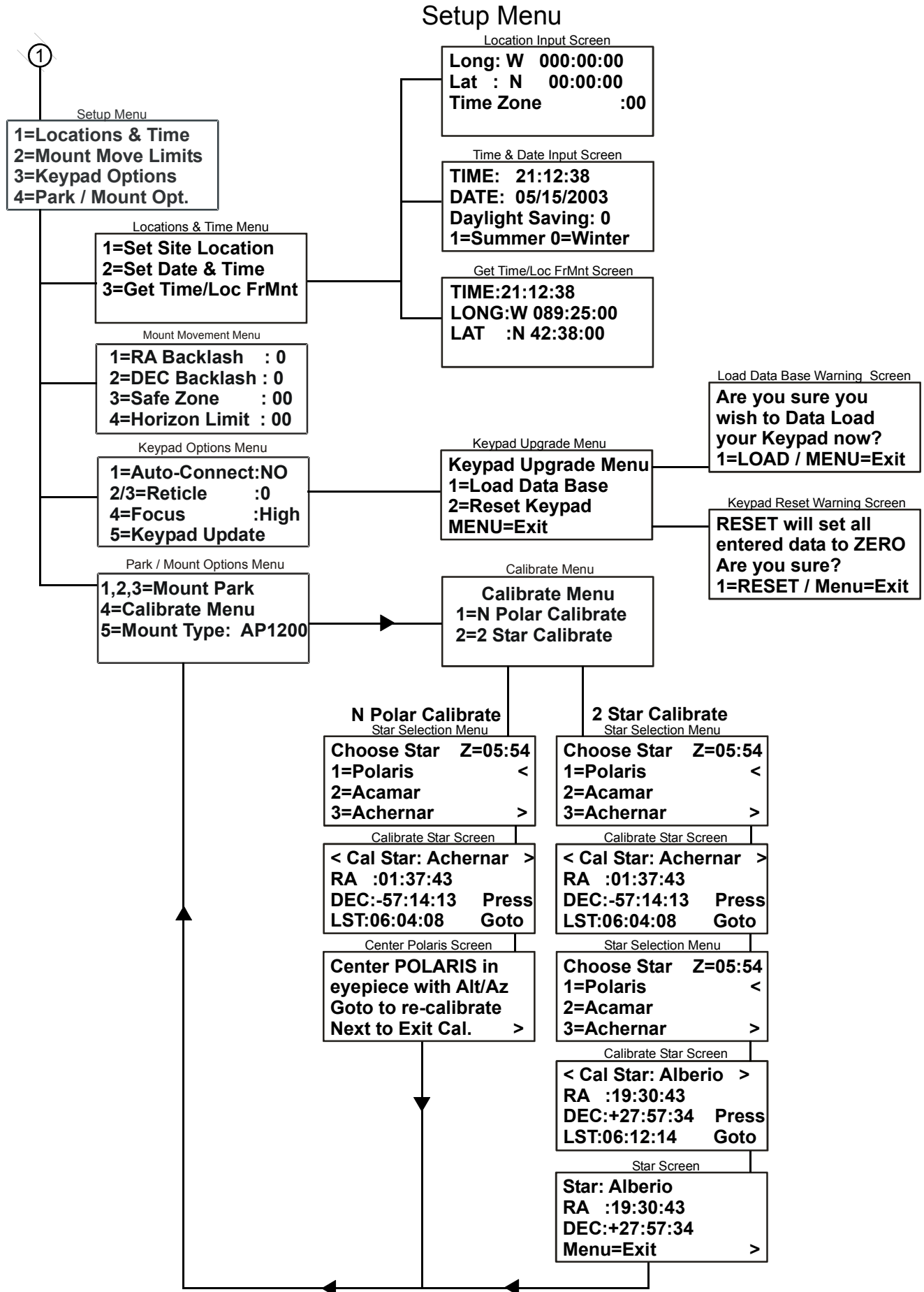

# Keypad Version 4.0 Screens and Map

## Tools Menu

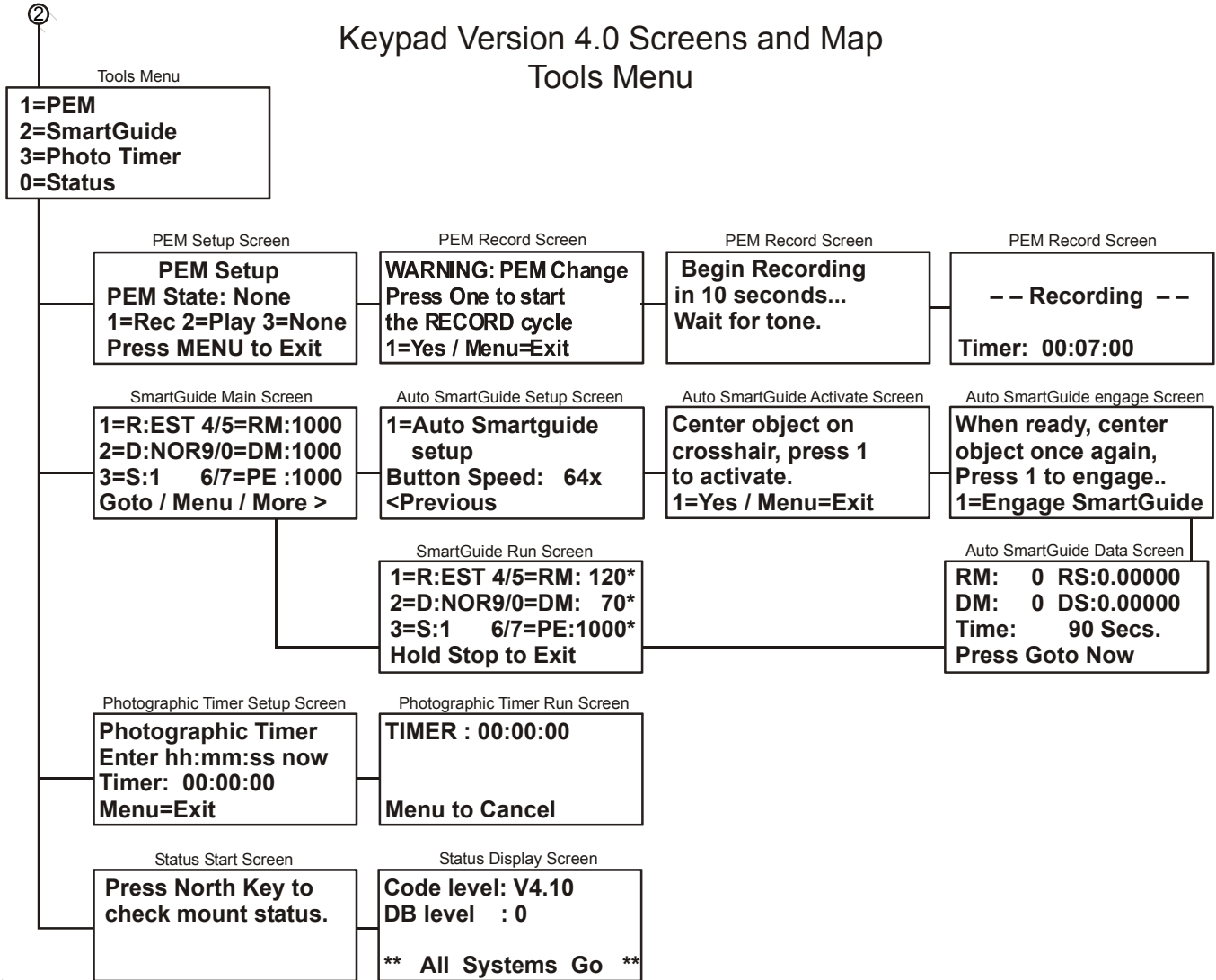

## Tour Menu

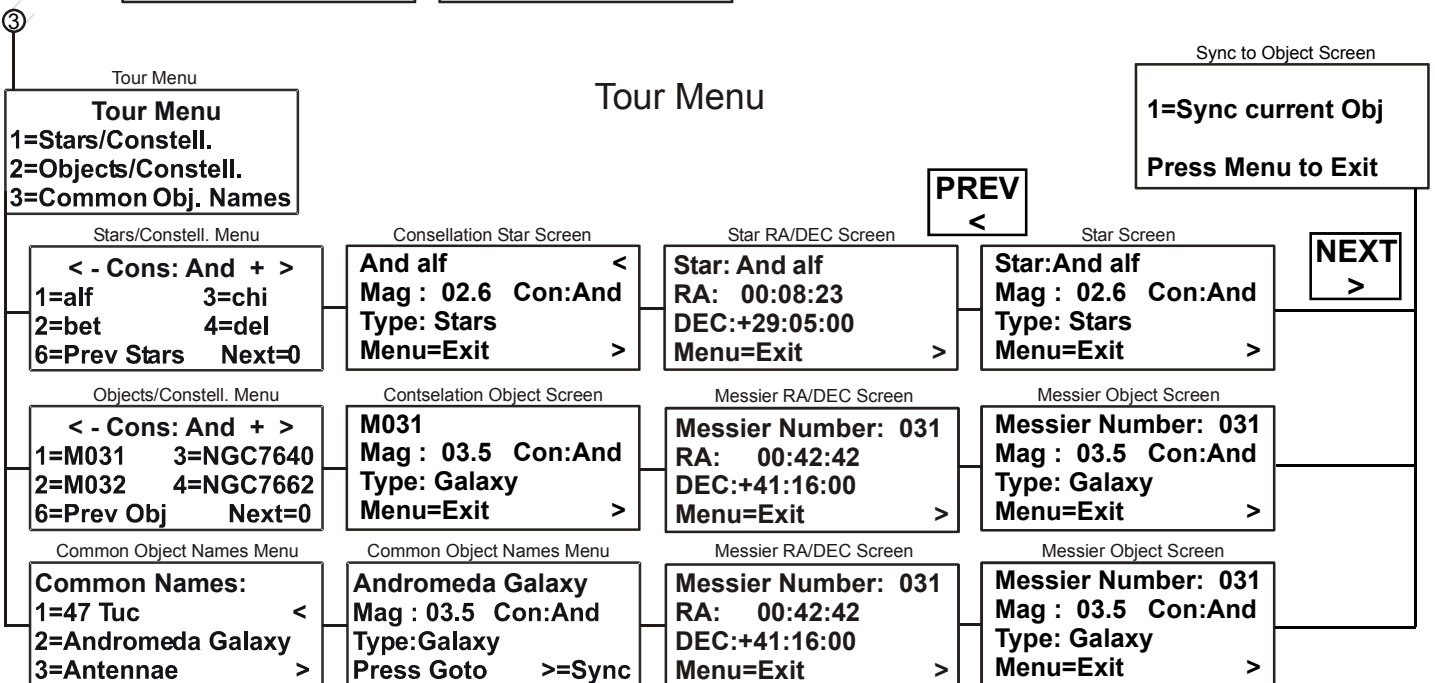

# Keypad Version 4.0 Screens and Map

## More Objects Menu

